

SERVICE MANUAL

TECHNICAL INFORMATION

FOR SERVICE PERSONNEL ONLY

REFER TO THE FOUNDATION MANUAL

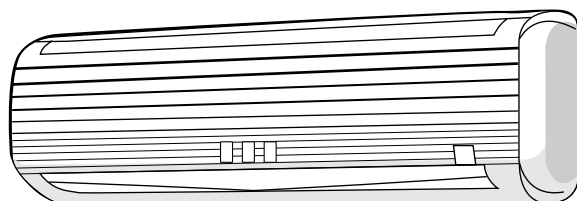

RAS-18G4

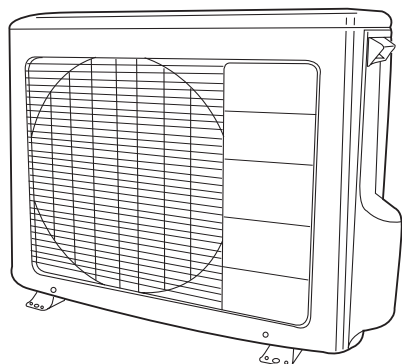

RAC-18G4



CONTENTS

SPECIFICATIONS	5
HOW TO USE	9
CONSTRUCTION AND DIMENSIONAL DIAGRAM	29
MAIN PARTS COMPONENT	31
WIRING DIAGRAM	33
CIRCUIT DIAGRAM	35
PRINTED WIRING BOARD LOCATION DIAGRAM	37
BLOCK DIAGRAM	39
BASIC MODE	41
REFRIGERATING CYCLE DIAGRAM	47
DESCRIPTION OF MAIN CIRCUIT OPERATION	48
AUTO SWING FUNCTION	52
SERVICE CALL Q & A	53
TROUBLE SHOOTING	58
PARTS LIST AND DIAGRAM	61

SPECIFICATIONS

TYPE		(WALL TYPE)	
		INDOOR UNIT	OUTDOOR UNIT
MODEL		RAS-18G4	RAC-18G4
POWER SOURCE		1 Ø, 50 Hz, 220 - 230 - 240V	
COOLING	TOTAL INPUT (W)	1550 - 1580 - 1610	
	TOTAL AMPERES (A)	7.42 - 7.23 - 7.06	
	CAPACITY	(kW)	5.10
(B.T.U./h)		17,410	
DIMENSIONS (mm)	W	1030	850
	H	295	650
	D	183	298
NET WEIGHT		(kg)	12
			55

※ After installation

SPECIFICATIONS AND PARTS ARE SUBJECT TO CHANGE FOR IMPROVEMENT

ROOM AIR CONDITIONER

INDOOR UNIT + OUTDOOR UNIT

SAFETY DURING REPAIR WORK

1. In order to disassemble and repair the unit in question, be sure to disconnect the power cord plug from the power outlet before starting the work.

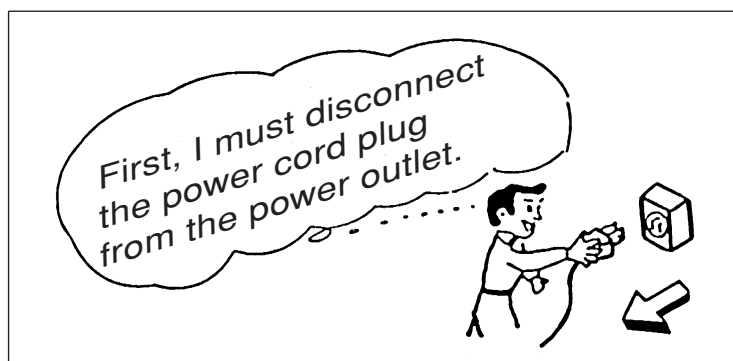

2. If it is necessary to replace any parts, they should be replaced with respective genuine parts for the unit, and the replacement must be effected in correct manner according to the instructions in the Service Manual of the unit.

If the contacts of electrical parts are defective, replace the electrical parts without trying to repair them.



3. After completion of repairs, the initial state should be restored.
4. Lead wires should be connected and laid as in the initial state.
5. Modification of the unit by user himself should absolutely be prohibited.
6. Tools and measuring instruments for use in repairs or inspection should be accurately calibrated in advance.
7. In installing the unit having been repaired, be careful to prevent the occurrence of any accident such as electrical shock, leak of current, or bodily injury due to the drop of any part.
8. To check the insulation of the unit, measure the insulation resistance between the power cord plug and grounding terminal of the unit. The insulation resistance should be $1M\Omega$ or more as measured by a 500V DC megger.
9. The initial location of installation such as window, floor or the other should be checked for being and safe enough to support the repaired unit again. If it is found not so strong and safe, the unit should be installed at the initial location reinforced or at a new location.
10. Any inflammable thing should never be placed about the location of installation.
11. Check the grounding to see whether it is proper or not, and if it is found improper, connect the grounding terminal to the earth.



WORKING STANDARDS FOR PREVENTING BREAKAGE OF SEMICONDUCTORS

1. Scope

The standards provide for items to be generally observed in carrying and handling semiconductors in relative manufacturers during maintenance and handling thereof. (They apply the same to handling of abnormal goods such as rejected goods being returned).

2. Object parts

- (1) Micro computer
- (2) Integrated circuits (IC)
- (3) Field-effect transistors (FET)
- (4) P.C. boards or the like on which the parts mentioned in (1) and (2) of this paragraph are equipped.

3. Items to be observed in handling

- (1) Use a conductive container for carrying and storing of parts. (Even rejected goods should be handled in the same way).

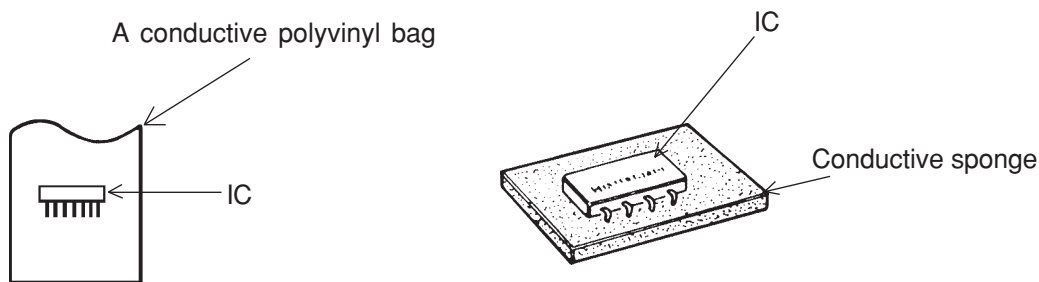

Fig. 1. Conductive Container

- (2) When any part is handled uncovered (in counting, packing and the like), the handling person must always use himself as a body earth. (Make yourself a body earth by passing one M ohm earth resistance through a ring or bracelet).
- (3) Be careful not to touch the parts with your clothing when you hold a part even if a body earth is being taken.
- (4) Be sure to place a part on a metal plate with grounding.
- (5) Be careful not to fail to turn off power when you repair the printed circuit board. At the same time, try to repair the printed circuit board on a grounded metal plate.

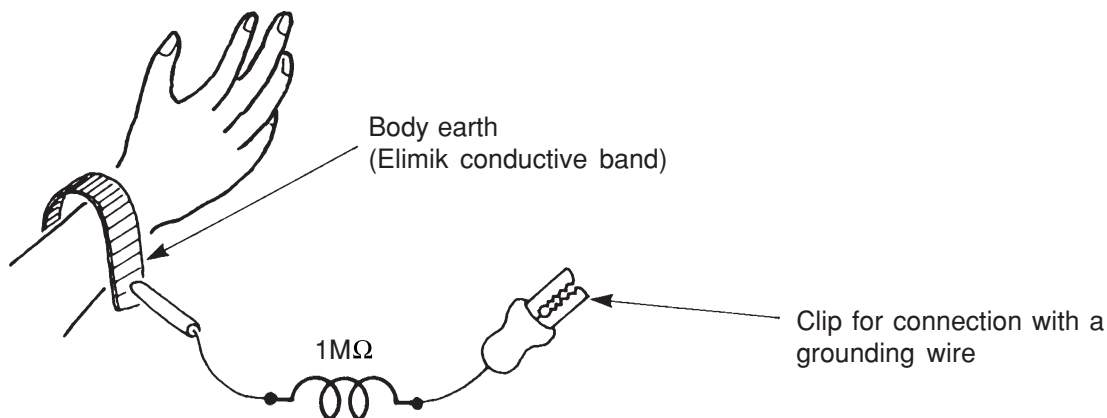

Fig. 2. Body Earth

(6) Use a three wire type soldering iron including a grounding wire.

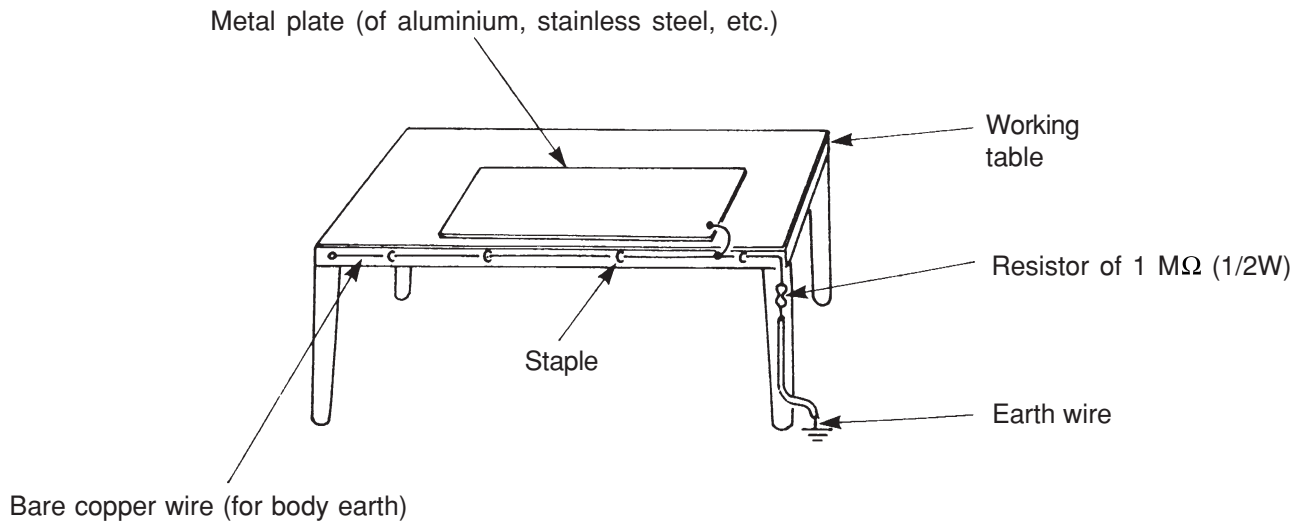

Fig. 3. Grounding of the working table

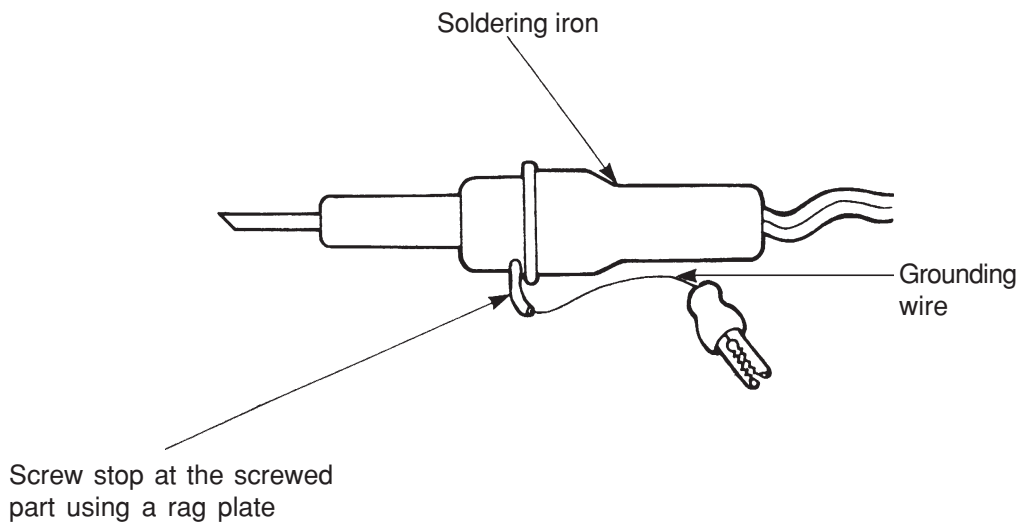

Fig. 4. Grounding a soldering iron

Use a high insulation mode (100V, 10MΩ or higher) when ordinary iron is to be used.

(7) In checking circuits for maintenance, inspection or some others, be careful not to have the test probes of the measuring instrument shortcircuit a load circuit or the like.

 **CAUTION**

1. In quiet or stop operation, slight flowing noise of refrigerant in the refrigerating cycle is heard occasionally, but this noise is not abnormal for the operation.
2. When it thunders near by, it is recommended to stop the operation and to disconnect the power cord plug from the power outlet for safety.
3. In the event of power failure, the air conditioner will restart automatically in the previously selected mode once the power is restored. In the event of power failure during TIMER operation, the timer will be reset and the unit will begin or stop operating under a new timer setting.
4. If the room air conditioner is stopped by adjusting thermostat, or missoperation, and re-start in a moment, there is occasion that the cooling and heating operation does not start for 3 minutes, it is not abnormal and this is the result of the operation of IC delay circuit. This IC delay circuit ensures that there is no danger of blowing fuse or damaging parts even if operation is restarted accidentally.
5. This room air conditioner should not be used at the cooling operation when the outside temperature is below 10°C (50°F).
6. This room air conditioner (the reverse cycle) should not be used when the outside temperature is below -10°C (14°F).
If the reverse cycle is used under this condition, the outside heat exchanger is frosted and efficiency falls.
7. When the outside heat exchanger is frosted, the frost is melted by operating the hot gas system, it is not trouble that at this time fan stops and the vapour may rise from the outside heat exchanger.

SPECIFICATIONS

MODEL		RAS-18G4	RAC-18G4
FAN MOTOR		20 W	30 W
FAN MOTOR CAPACITOR		NO	2.5 μ F, 450V
FAN MOTOR PROTECTOR		NO	YES (INTERNAL)
COMPRESSOR		–	5KS205DAA
COMPRESSOR MOTOR CAPACITOR		NO	50 μ F, 450VAC
OVERLOAD PROTECTOR		NO	YES (INTERNAL)
OVERHEAT PROTECTOR		NO	YES (INTERNAL)
FUSE (MICRO COMPUTER CIRCUIT)		3.15A	NO
POWER RELAY		G4A	NO
POWER SWITCH		YES	NO
TEMPORARY SWITCH		NO	NO
SERVICE SWITCH		YES	NO
TRANSFORMER		NO	NO
VARISTOR		450NR	NO
NOISE SUPPRESSOR		NO	NO
THERMOSTAT		YES(IC)	YES(IC)
REMOTE CONTROL SWITCH (LIQUID CRYSTAL)		YES	NO
FUSE CAPACITY		20 A TIME DELAY FUSE	
REFRIGERANT CHARGING VOLUME (Refrigerant R410A)	UNIT	-----	* 1450g
	PIPES (MAX. 15m) (MIN. 5m)	ADDITIONAL REFRIGERANT R410A AT 15g PER EVERY METER IF PIPE LENGTH MORE THAN 8m.	

Figure showing the installation of Indoor and Outdoor unit



CAUTION

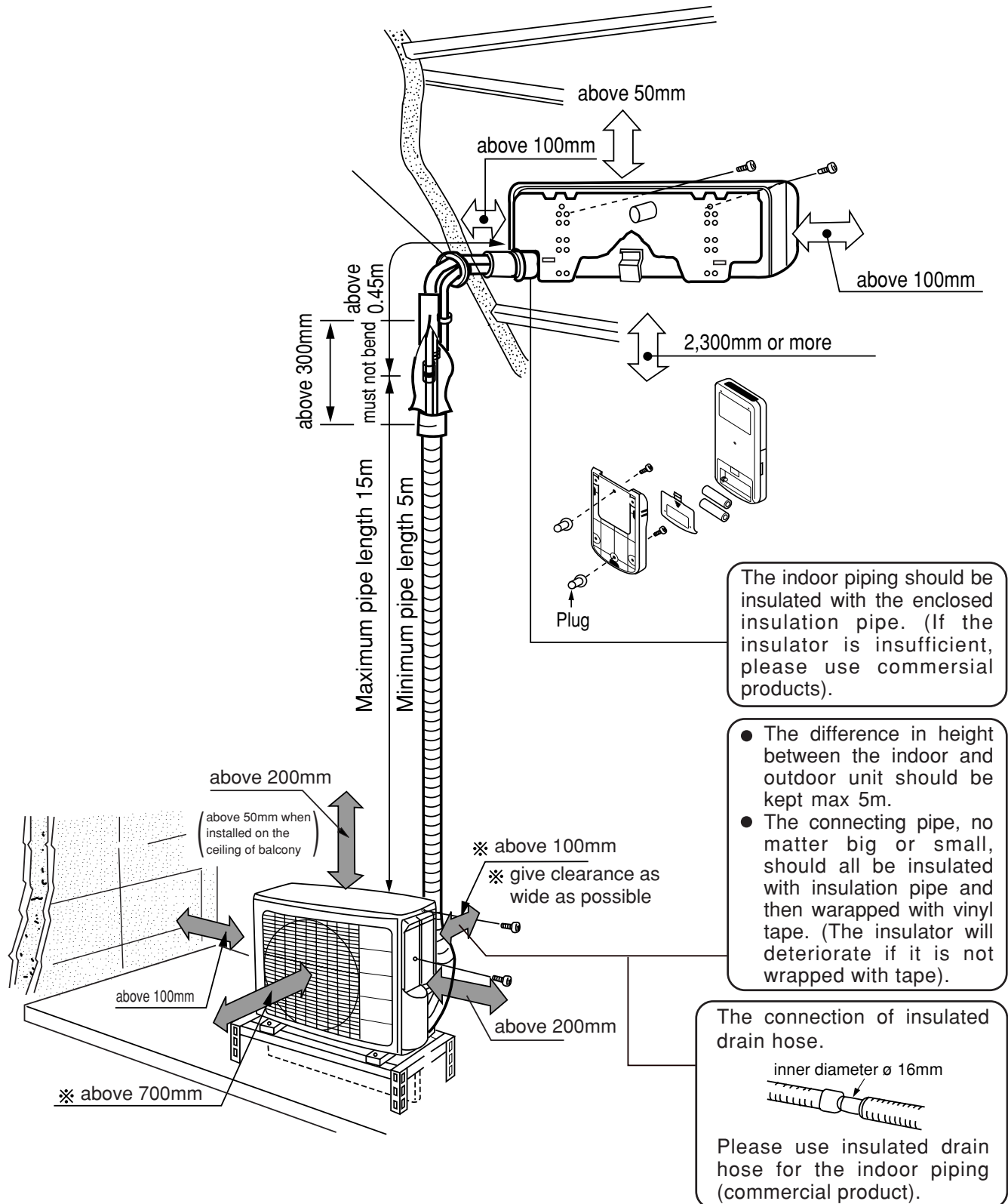

The installation height of indoor unit must be 2.3m or more in a non public area









SAFETY PRECAUTION

- Please read the “Safety Precaution” carefully before operating the unit to ensure correct usage of the unit.
- Pay special attention to signs of “**▲ Warning**” and “**▲ Caution**”. The “Warning” section contains matters which, if not observed strictly, may cause death or serious injury. The “Caution” section contains matters which may result in serious consequences if not observed properly. Please observe all instructions strictly to ensure safety.
- The sign indicate the following meanings.

 Make sure to connect earth line.	 The sign in the figure indicates prohibition.
 Indicates the instructions that must be followed.	

- Please keep this manual after reading.



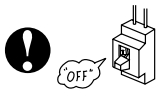

PRECAUTIONS DURING INSTALLATION

 WARNING	<ul style="list-style-type: none"> ● Do not reconstruct the unit. Water leakage, fault, short circuit or fire may occur if you reconstruct the unit by yourself. 	
	<ul style="list-style-type: none"> ● Please ask your sales agent or qualified technician for the installation of your unit. Water leakage, short circuit or fire may occur if you install the unit by yourself. 	
 CAUTION	<ul style="list-style-type: none"> ● Please use earth line. Do not place the earth line near water or gas pipes, lightning-conductor, or the earth line of telephone. Improper installation of earth line may cause electric shock. 	
	<ul style="list-style-type: none"> ● A circuit breaker should be installed depending on the mounting site of the unit. Without a circuit breaker, the danger of electric shock exists. ● Do not install the unit near a location where there is flammable gas. The outdoor unit may catch fire if flammable gas leaks around it. ● Please ensure smooth flow of water when installing the drain hose. 	

PRECAUTIONS DURING SHIFTING OR MAINTENANCE

 W A R N I N G	<ul style="list-style-type: none"> ● Should abnormal situation arises (like burning smell), please stop operating the unit and turn off the circuit breaker. Contact your agent. Fault, short circuit or fire may occur if you continue to operate the unit under abnormal situation. 	
	<ul style="list-style-type: none"> ● Please contact your agent for maintenance. Improper self maintenance may cause electric shock and fire. 	
	<ul style="list-style-type: none"> ● Please contact your agent if you need to remove and reinstall the unit. Electric shock or fire may occur if you remove and reinstall the unit yourself improperly. 	

PRECAUTIONS DURING OPERATION

 W A R N I N G	<ul style="list-style-type: none"> ● Avoid an extended period of direct air flow for your health. 	
	<ul style="list-style-type: none"> ● Do not insert a finger, a rod or other objects into the air outlet or inlet. As the fan is rotating at a high speed, it will cause injury. Before cleaning, be sure to stop the operation and turn the breaker OFF. 	
	<ul style="list-style-type: none"> ● Do not use any conductor as fuse wire, this could cause fatal accident. 	
	<ul style="list-style-type: none"> ● During thunder storm, disconnect and turn off the circuit breaker. 	

PRECAUTIONS DURING OPERATION

- The product shall be operated under the manufacturer specification and not for any other intended use.

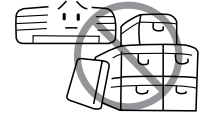

- Do not attempt to operate the unit with wet hands, this could cause fatal accident.

- When operating the unit with burning equipments, regularly ventilate the room to avoid oxygen insufficiency.

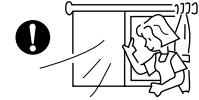

- Do not direct the cool air coming out from the air-conditioner panel to face household heating apparatus as this may affect the working of apparatus such as the electric kettle, oven etc.

- Please ensure that outdoor mounting frame is always stable, firm and without defect. If not, the outdoor unit may collapse and cause danger.



- Do not splash or direct water to the body of the unit when cleaning it as this may cause short circuit.

- Do not use any aerosol or hair sprays near the indoor unit. This chemical can adhere on heat exchanger fin and blocked the evaporation water flow to drain pan. The water will drop on tangential fan and cause water splashing out from indoor unit.



- Please switch off the unit and turn off the circuit breaker during cleaning, the high-speed fan inside the unit may cause danger.



- Turn off the circuit breaker if the unit is not to be operated for a long period.

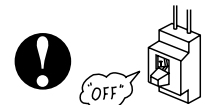

- Do not climb on the outdoor unit or put objects on it.



- Do not put water container (like vase) on the indoor unit to avoid water dripping into the unit. Dripping water will damage the insulator inside the unit and causes short-circuit.

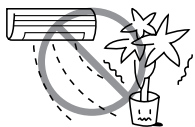

- Do not place plants directly under the air flow as it is bad for the plants.

- When operating the unit with the door and windows opened, (the room humidity is always above 80%) and with the air deflector facing down or moving automatically for a long period of time, water will condense on the air deflector and drips down occasionally. This will wet your furniture. Therefore, do not operate under such condition for a long time.
- If the amount of heat in the room is above the cooling or heating capability of the unit (for example: more people entering the room, using heating equipments and etc.), the preset room temperature cannot be achieved.

CAUTION

NAMES AND FUNCTIONS OF EACH PART

INDOOR UNIT

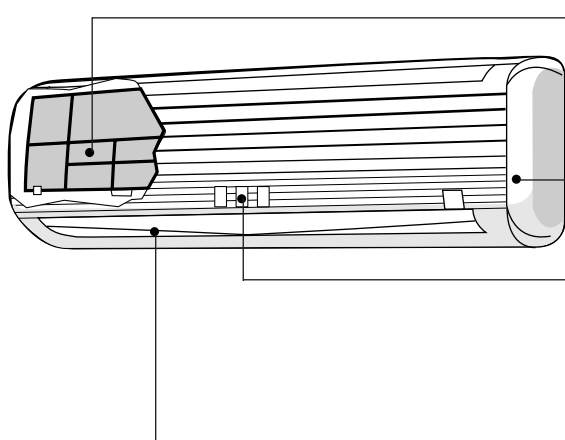

Air filter

To prevent dust from coming into the indoor unit.
(Refer page 25)

Front panel

Indoor unit indicators

Light indicator showing the operating condition.
(Refer page 10)

Horizontal deflector • Vertical deflector (Air Outlet)

(Refer page 16)

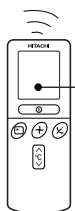

Remote controller

Send out operation signal to the indoor unit. So as to operate the whole unit.
(Refer page 11)

OUTDOOR UNIT

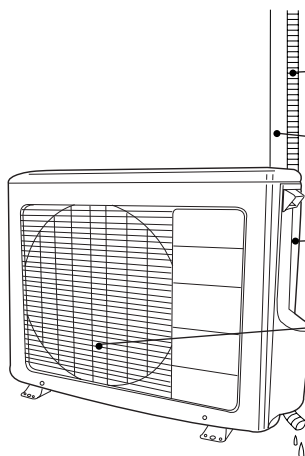

Drain pipe

Condensed water drain to outside.

Connecting cord and insulation pipe for piping

Air inlet (Back and Left side)

Air outlet

MODEL NAME AND DIMENSIONS

MODEL	WIDTH (mm)	HEIGHT (mm)	DEPTH (mm)
RAS-18G4	1030	295	183
RAC-18G4	850	650	298

INDOOR UNIT INDICATORS

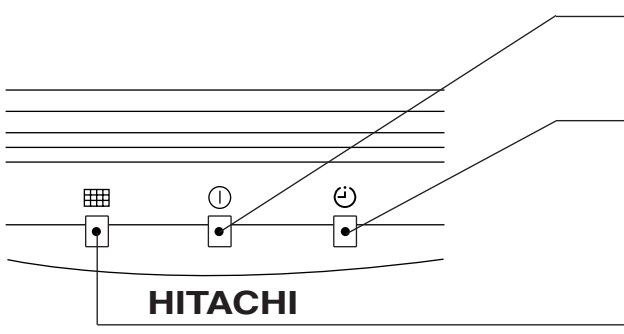

OPERATION LAMP

This lamp lights during operation.

FILTER LAMP

When the device is operated for a total of about 200 hours, the FILTER lamp lights to indicate that it is time to clean the filter. The lamp goes out when the POWER SWITCH set to OFF and ON again.

TIMER LAMP

This lamp lights when the timer is working.

OPERATION INDICATOR

- This figure shows the opening condition of front panel. Refer to page 24 in relation to how to open or close the front panel.

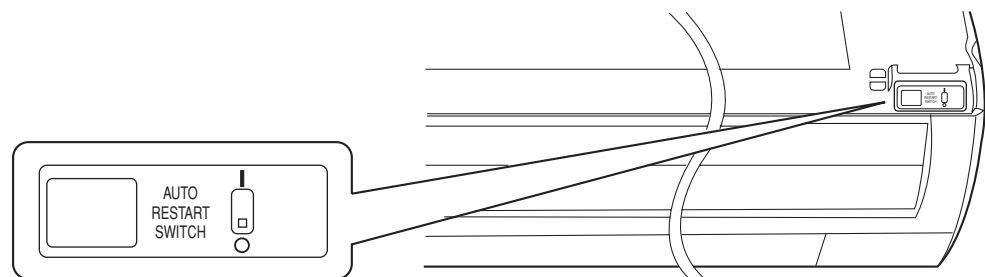

AUTO RESTART SWITCH

- In the event of power failure, the air conditioner will restart automatically in the previously selected mode once the power is restored.
- In the event of power failure during TIMER operation, the timer will be reset and the unit will begin or stop operating under a new timer setting.

NAMES AND FUNCTIONS OF REMOTE CONTROL UNIT

REMOTE CONTROLLER

This controls the operation of the indoor unit. The range of control is about 7 meters. If indoor lighting is controlled electronically, the range of control may be shorter.

This unit can be fixed on a wall using the fixture provided. Before fixing it, make sure the indoor unit can be controlled from the remote controller.

Signal emitting window/transmission sign
Point this window toward the indoor unit when controlling it. The transmission sign blinks when a signal is sent.

Display
This indicates the room temperature selected, current time, timer status, function and intensity of circulation selected.

START/STOP button
Press this button to start operation. Press it again to stop operation.

SLEEP button
Use this button to set the sleep timer.

TEMPERATURE button
Use this button to raise or lower the temperature setting. (Keep pressed, and the value will change more quickly.)

OFF-TIMER button Select the turn OFF time.

ON-TIMER button Select the turn ON time.

TIME button
Use this button to set and check the time and date.

RESET button

FUNCTION selector
Use this button to select the operating mode. Every time you press it, the mode will change from ☺ (AUTO) to ❄ (COOL) to ☹ (DEHUMIDIFY) to ☼ (CIRCULATION) and to ↻ (FAN) cyclically.

FAN SPEED selector
This determines the fan speed. Every time you press this button, the intensity of circulation will change from ☺ (AUTO) to 🌀 (HI) to 🌀 (MED) to 🌀 (LOW) (during the ↻ (FAN) mode, from 🌀 HI to 🌀 MED to 🌀 LOW).

AUTO SWING button
Controls the angle of the horizontal air deflector.

TIMER control
Use this button to set the timer.

RESERVE button Time setting reservation.

CANCEL button Cancel time reservation.

☺	AUTO
❄	COOL
☹	DEHUMIDIFY
☼	CIRCULATION
↻	FAN
🌀	FAN SPEED LOW MED HI
★	SLEEPING
○	STOP (CANCEL)
I	START (RESERVE)
⏻	START/STOP
⌚	TIME
⌚	TIMER SET
⌚	TIMER SELECTOR ON TIMER OFF TIMER
↔	AUTO SWING

Precautions for Use

- Do not put the remote controller in the following places.
 - Under direct sunlight.
 - In the vicinity of a heater.
- Handle the remote controller carefully. Do not drop it on the floor, and protect it from water.
- Once the outdoor unit stops, it will not restart for about 3 minutes (unless you turn the power switch off and on or unplug the power cord and plug it in again).
This is to protect the device and does not indicate a failure.
- If you press the FUNCTION selector button during operation, the device may stop for about 3 minutes for protection.

AUTOMATIC OPERATION

The device will automatically determine the mode of operation COOL, or Dehumidify, depending on the initial room temperature. The selected mode of operation will not change when the room temperature varies.

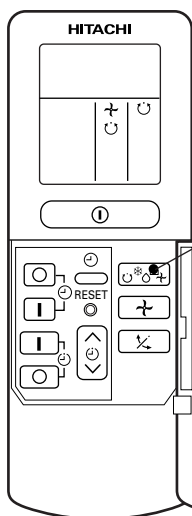

1

Press the FUNCTION selector so that the display indicates the  (AUTO) mode of operation.

- When AUTO has been selected, the device will automatically determine the mode of operation COOL or Dehumidify, depending on the initial room temperature and outdoor temperature.

START STOP

Press the  (START/STOP) button.

Operation starts with a beep.

Press the button again to stop operation.

- As the settings are stored in memory in the remote controller, you only have to press the  (START/STOP) button next time.

You can raise or lower the temperature setting as necessary by maximum of 3°C.

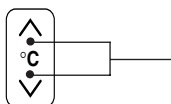

Press the temperature button and the temperature setting will change by 1°C each time.

- The preset temperature and the actual room temperature may vary somewhat depending on conditions.
- The display does not indicate the preset temperature in the AUTO mode. If you change the setting, the indoor unit will produce a beep.

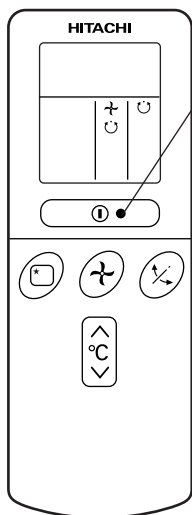

■ CONDITION OF AUTOMATIC OPERATION

- The selected mode of operation will not change during the operation even though the room temperature change.

INITIAL ROOM TEMPERATURE (APPROX.)	FUNCTION	TEMPERATURE SETTING	FAN SPEED
Over 27°C	➔ COOL	27°C	HIGH at start, LOW after the preset temperature is reached.
16~27°C	➔ DEHUMIDIFY	Slightly lower than the room temperature	LOW

COOLING OPERATION

Use the device for cooling when the outdoor temperature is 22-42°C.
If indoor humidity is very high (80%), some dew may form on the air outlet grille of the indoor unit.

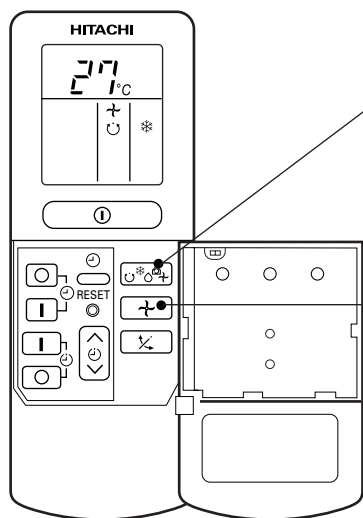

1

Press the FUNCTION selector so that the display indicates * (COOL).

Set the desired FAN SPEED with the ↻ (FAN SPEED) button (the display indicates the setting).

☺ (AUTO): The FAN SPEED is HI at first and varies to MED automatically when the preset temperature has been reached.

≡ (HI) : Economical as the room will become cool quickly.

≡ (MED) : Quiet.

≡ (LOW) : More quiet.

2

Set the desired room temperature with the TEMPERATURE button (the display indicates the setting).

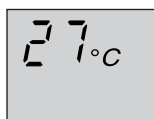

The range of 25-28°C is recommended as the room temperature for cooling.

If the temperature setting is 27°C, the room temperature will be controlled at around 27°C.

The temperature setting and the actual room temperature may vary some how depending on conditions.

3

**START
STOP**

Press the ⏻ (START/STOP) button. Cooling operation starts with a beep. Press the button again to stop operation. The cooling function does not start if the temperature setting is higher than the current room temperature (even though the ⏻ (OPERATION) lamp lights). The cooling function will start as soon as you set the temperature below the current room temperature.

■ As the settings are stored in memory in the remote controller, you only have to press the ⏻ (START/STOP) button next time.

DEHUMIDIFYING OPERATION

Use the device for dehumidifying when the room temperature is over 16°C.
When it is under 15°C, the dehumidifying function will not work.

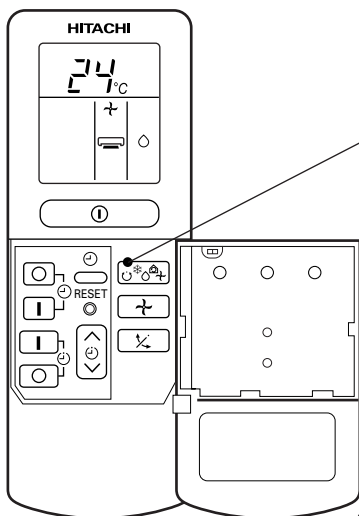

1

Press the FUNCTION selector so that the display indicates ◊ (DEHUMIDIFY).
The FAN SPEED is set at LOW automatically.
The FAN SPEED button does not work.

2

Set the desired room temperature with the TEMPERATURE button (the display indicates the setting).

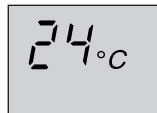

The range of 20-26°C is recommended as the room temperature for dehumidifying.

**START
STOP**

Press the ① (START/STOP) button. Dehumidifying operation starts with a beep. Press the button again to stop operation.

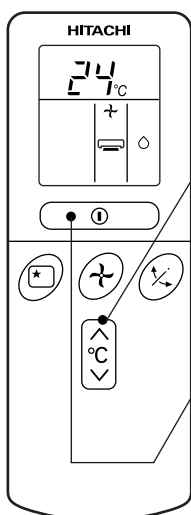

- As the settings are stored in memory in the remote controller, you only have to press the ① (START/STOP) button next time.

■ Dehumidifying Function

When the room temperature is higher than the temperature setting: The device will dehumidify the room, reducing the room temperature to the preset level.

When the room temperature is lower than the temperature setting: Dehumidifying will be performed at the temperature setting slightly lower than the current room temperature, regardless of the temperature setting. The function will stop (the indoor unit will stop emitting air) as soon as the room temperature becomes lower than the setting temperature.

FAN OPERATION

You can use the device simply as an air circulator. Use this function to dry the interior of the indoor unit at the end of summer.

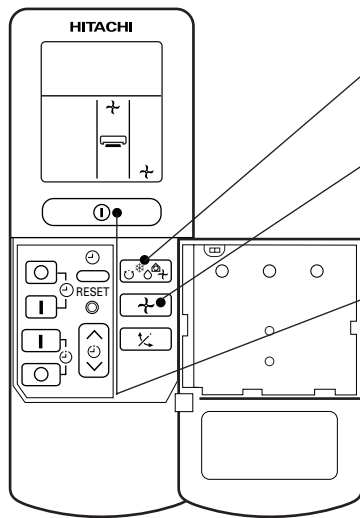

1

Press the FUNCTION selector so that the display indicates (FAN).

2

Press the (FAN SPEED) button.*

**START
STOP**

Press the (START/STOP) button. Fan operation starts with a beep. Press the button again to stop operation.

* Note • In the fan operation mode, only display of FAN SPEED setting will change by pressing FAN SPEED button; the actual fan speed cannot be changed directly from HI to LOW mode.

FAN SPEED (AUTO)

..... When the AUTO fan speed mode is set in the cooling operation:

For the cooling operation

- When the difference of room temperature and setting temperature is large, fan starts to run at HI speed.
- After room temperature reaches the preset temperature, the cooling operation, which changes the fan speed and room temperature to obtain optimum conditions for natural healthful cooling will be performed.

CIRCULATION OPERATION

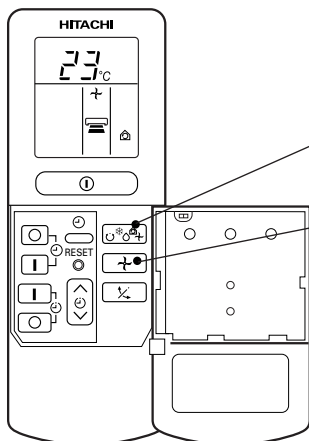

1

Press the FUNCTION selector so that the display indicates (CIRCULATE).

2

Press the FAN SPEED button and select the desired FAN SPEED (the display indicates your choice).

3

Press the temperature control button to set to the desired temperature.

**START
STOP**

Press the (START/STOP) button. Circulating operation starts with a beep. Press the button again to stop operation.

- As the settings are stored in memory in the remote controller, you only have to press the (START/STOP) button next time.

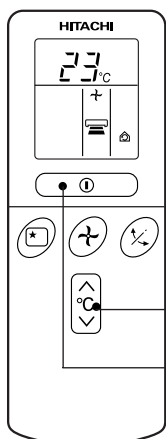

ADJUSTING THE AIR DEFLECTOR

- 1** Adjustment of the conditioned air in the upward and downward directions.

The horizontal air deflector is automatically set to the proper angle suitable for each operation. The deflector can be swung up and down continuously and also set to the desired angle using the “ (AUTO SWING)” button.

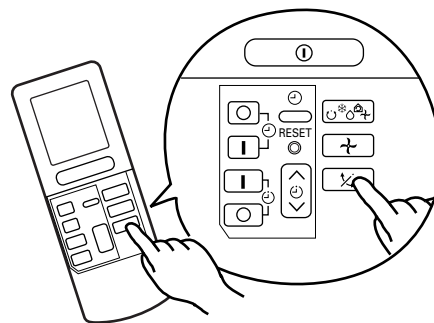

- If the “ (AUTO SWING)” button is pressed once, the horizontal air deflector swings up and down. If the button is pressed again, the deflector stops in its current position. Several seconds (about 6 seconds) may be required before the deflector starts to move.
- Use the horizontal air deflector within the adjusting range shown on the right.
- When the operation is stopped, the horizontal air deflector moves and stops at the position where the air outlet closes.

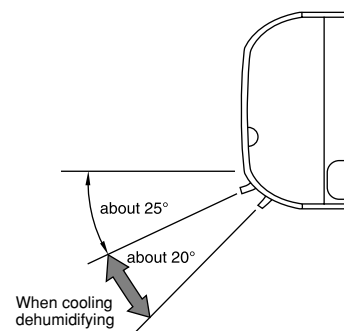

CAUTION

- In “Cooling” operation, do not keep the horizontal air deflector swinging for a long time. Some dew may form on the horizontal air deflector and dew may drop.

- 2** Adjustment of the conditioned air to the left and right.

Hold the vertical air deflector as shown in the figure and adjust the conditioned air to the left and right.

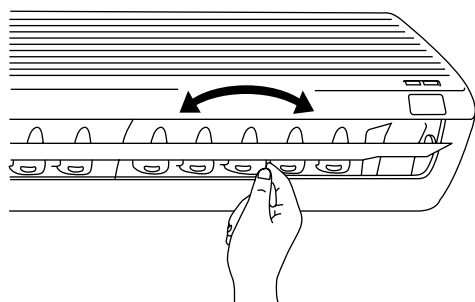

CAUTION

- When operating the unit in cooling operation with the air deflector facing down and moving automatically for a long period of time, water will condensed on the air deflector and drips down occasionally. This will wet your furniture.

HOW TO SET THE SLEEP TIMER

Set the current time first if it is not set before (see the pages for setting the current time). Press the  (SLEEP) button, and the display changes as shown below.

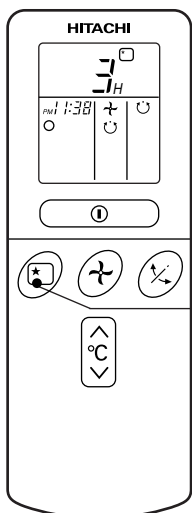

• SLEEP

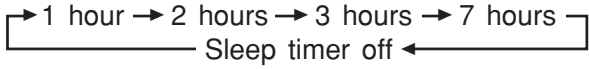
Mode	Indication
Sleep timer	

Sleep Timer: The device will continue working for the designated number of hours and then turn off. Point the signal window of the remote controller toward the indoor unit, and press the SLEEP button. The timer information will be displayed on the remote controller. The TIMER lamp lights with a beep from the indoor unit. When the sleep timer has been set, the display indicates the turn-off time.

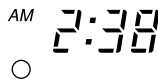

Example: If you set 3 hours sleep time at 11:38 p.m., the turn-off time is 2:38 a.m.

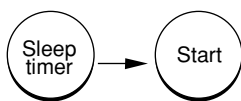

The device will be turned off by the sleep timer and turned on by on-timer.

1 Set the ON-timer.

2 Press the  (SLEEP) button and set the sleep timer.

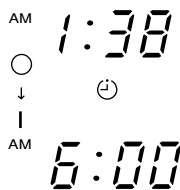
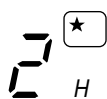

In this case, the device will turn off in 2 hours (at 1:38 a.m.) and starts at 6:00 a.m. next morning.

How to Cancel Reservation

Point the signal window of the remote controller toward the indoor unit, and press the  (CANCEL) button.

The  (RESERVED) sign goes out with a beep and the  (TIMER) lamp turns off on the indoor unit.

HOW TO SET THE TIMER

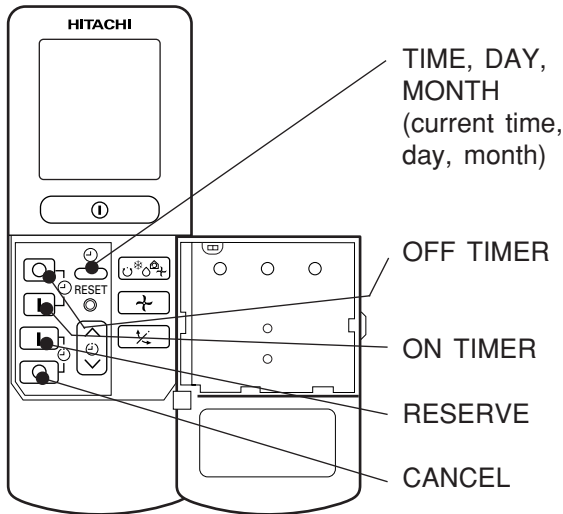

Time, Day, Month

After you change the batteries;

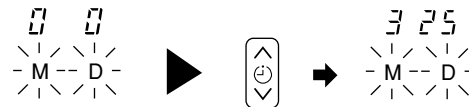

1 Set the current month and day with the TIMER control button.

OFF-Timer

1 Press the (OFF-TIMER) button. The (OFF) mark blinks on the display.

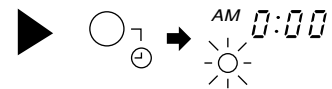
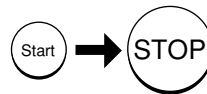

You can set the device to turn off at the present time.

ON-Timer

- The device will turn on at the designated times.

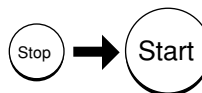

1 Press the (ON-TIMER) button the (ON) mark blinks on the display.

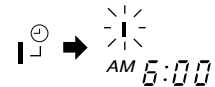

ON/OFF-Timer

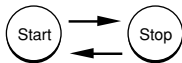

- The device will turn on (off) and off (on) at the designated times.
- The switching occurs first at the preset time that comes earlier.
- The arrow mark appearing on the display indicates the sequence of switching operations.

1 Press the (ON-OFF) button so that the (OFF) mark blinks.

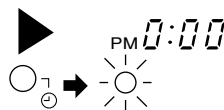

2 Set the turn-off time with the TIMER control button. Press the (RESERVE) button.

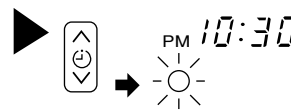

3 Press the (ON-TIMER) button so that the (OFF) mark lights and the (ON) mark blinks.

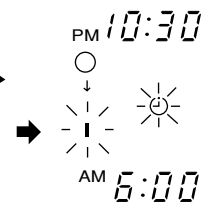

How to Cancel Reservation

Point the signal window of the remote controller toward the indoor unit, and press the (CANCEL) button.

The (RESERVED) sign goes out with a beep and the (TIMER) lamp turns off on the indoor unit.

NOTE

You can set only one of the OFF-timer, ON-timer and ON/OFF-timer.

2 Press the ⊖ (TIME) button.



3 Set the current time with the TIMER control button.

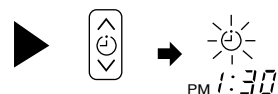

4 Press the ⊖ (TIME) button again. The time indication starts lighting instead of flashing.

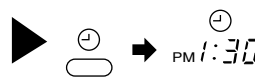

- The time indication will disappear automatically in 10 seconds.
- To check the current time setting, press the ⊖ (TIME) button twice.

The setting of the current time is now complete.

Example: The current time is 1:30 p.m.

2 Set the turn-off time with the TIMER control button.

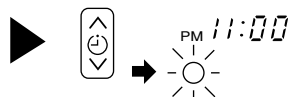

3 Point the signal window of the remote controller toward the indoor unit, and press the | (RESERVE) button.

The ○ (OFF) mark starts lighting instead of flashing and the sign ⊖ (RESERVED) lights. A beep occurs and the ⊖ (TIMER) lamp lights on the indoor unit.

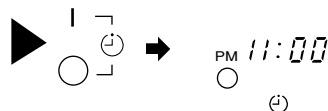

Example: The device will turn off at 11:00p.m.

The setting of turn-off time is now complete.

2 Set the turn-on time with the TIMER control button.

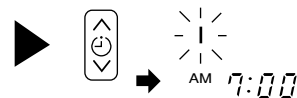

3 Point the signal window of the remote controller toward the indoor unit, and press the | (RESERVE) button.

The | (ON) mark starts lighting instead of flashing and the ⊖ (RESERVED) sign lights. A beep occurs and the ⊖ (TIMER) lamp lights on the indoor unit.

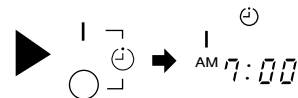

Example:

The device will automatically turn on earlier so that the preset temperature can be reached at 7:00 a.m.

The setting of the turn-on time is now complete.

4 Set the turn-on time with the TIMER control button.

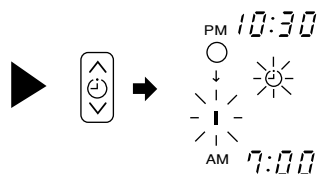

5 Point the signal window of the remote controller toward the indoor unit, and press the | (RESERVE) button.

The | (ON) mark starts lighting instead of flashing and the ⊖ (RESERVED) sign lights. A beep occurs and the ⊖ (TIMER) lamp lights on the indoor unit.

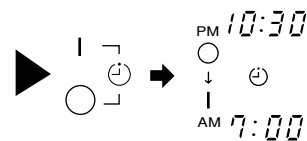

Example:

The device will turn off at 10:30 p.m. and then automatically turn on earlier so that the preset temperature can be reached at 7:00 a.m.

The settings of the turn-on/off times are now complete.

- The timer may be used in three ways: off-timer, on-timer, and ON/OFF (OFF/ON)-timer. Set the current time at first because it serves as a reference.
- As the time settings are stored in memory in the remote controller, you only have to press the | (RESERVE) button in order to use the same settings next time.

Explanation of the sleep timer

The device will control the FAN SPEED and room temperature automatically so as to be quiet and good for people's health.

You can set the sleep timer to turn off after 1, 2, 3 or 7 hours. The FAN SPEED and room temperature will be controlled as shown below.

Operation with the sleep timer

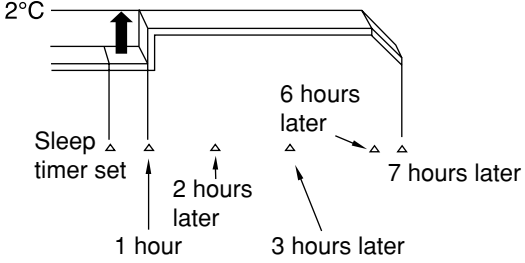
Function	Operation
Cooling “ ❄ ” and dehumidifying “ 💧 ”	<p>The room temperature will be controlled 2°C above the temperature and the FAN SPEED will be set to LOW setting 1 hour after the setting of the sleep timer.</p> 
Fan “ ↻ ”	<p>The settings of room temperature and circulation are varied.</p>

NOTE

- If date or current time is not set, sleep timer can not be set.
- If you set the sleep timer after the off-, on/off- or off/on-timer has been set, the sleep timer becomes effective instead of the off-, on/off- or off/on-timer set.
- You can not set other timer during sleep timer operation.
- The angle of horizontal air deflector shifts up automatically after three hours on sleep timer operation.
- Fan will stop for a while if room temperature reaches setting temperature.

HOW TO EXCHANGE THE BATTERIES IN THE REMOTE CONTROLLER

1 Remove the cover as shown in the figure and take out the old batteries.



2 Install the new batteries.
The direction of the batteries should match the marks in the case.

⚠ CAUTION

1. Do not use new and old batteries, or different kinds of batteries together.
2. Take out the batteries when you do not use the remote controller for 2 or 3 months.

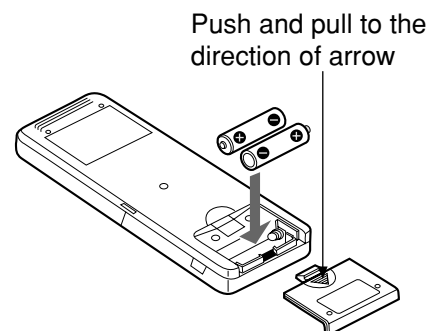

THE IDEAL WAYS OF OPERATION

Suitable Room Temperature

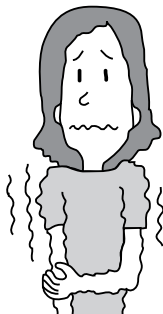

⚠ Warning
Freezing temperature is bad for health and a waste of electric power.

Install curtain or blinds

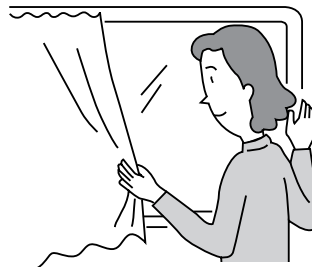

It is possible to reduce heat entering the room through windows.

Ventilation

⚠ Caution
Do not close the room for a long period of time. Occasionally open the door and windows to allow the entrance of fresh air.



Effective Usage Of Timer

At night, please use the “OFF or ON timer operation mode”, together with your wake up time in the morning. This will enable you to enjoy a comfortable room temperature. Please use the timer effectively.

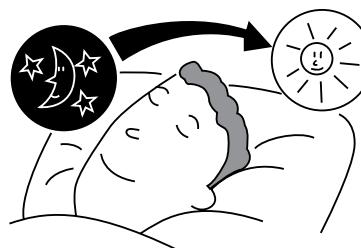

Do Not Forget To Clean The Air Filter

Dusty air filter will reduce the air volume and the cooling efficiency. To prevent from wasting electric energy, please clean the filter every 2 weeks.

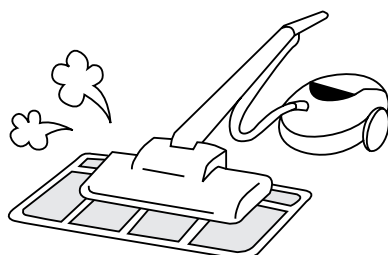

Please Adjust Suitable Temperature For Baby And Children

Please pay attention to the room temperature and air flow direction when operating the unit for baby, children and old folks who have difficulty in movement.

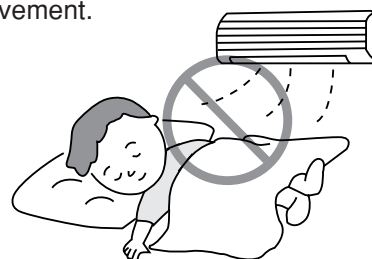

FOR USER'S INFORMATION

The Air Conditioner And The Heat Source In The Room

⚠ Caution

If the amount of heat in the room is above the cooling capability of the air conditioner (for example: more people entering the room, using heating equipments and etc.), the preset room temperature cannot be achieved.

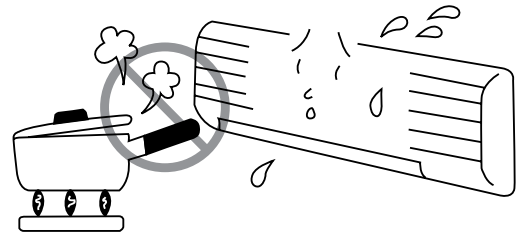

Not Operating For A Long Time

When the indoor unit is not to be used for a long period of time, please switch off the power from the mains. If the power from mains remains "ON", the indoor unit still consumes about 8W in the operation control circuit even if it is in "OFF" mode.

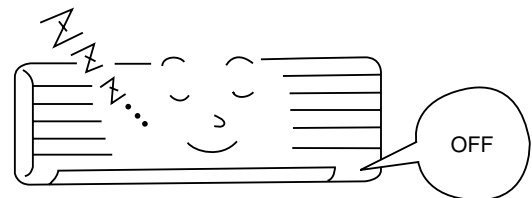

When Lightning Occurs

⚠ Warning

To protect the whole unit during lightning, please stop operating the unit and remove the plug from the socket.

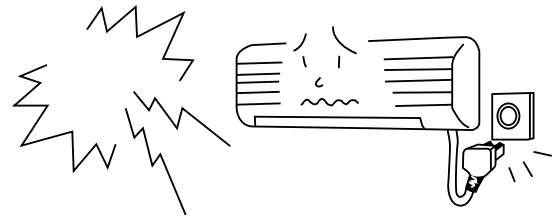

Interference From Electrical Products

⚠ Caution

To avoid noise interference, please place the indoor unit and its remote controller at least 1m away from electrical products.

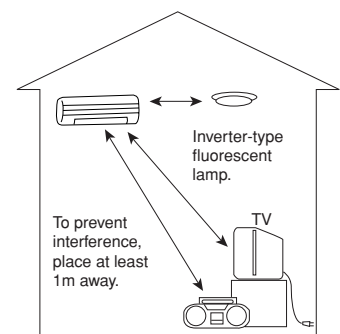

ATTACHING THE AIR CLEANSING AND DEODORIZING FILTERS

⚠ CAUTION

Cleaning and maintenance must be carried out only by qualified service personal. Before cleaning, stop operation and switch off the power supply.

1 Open the front panel.

- Pull up the front panel by holding it at both sides with both hands.

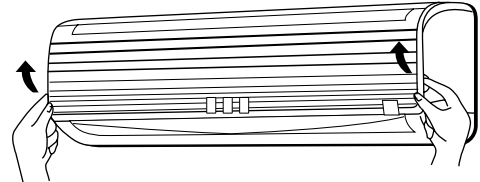

2 Remove the filter.

- Push upward to release the claws and pull out the filter.

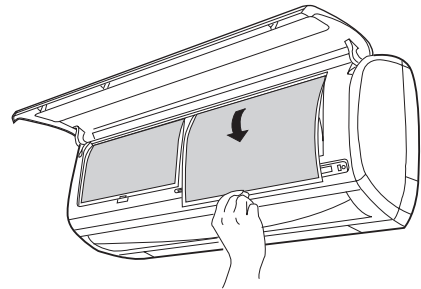

3 Attaching the air cleansing and deodorizing filters to the filter.

- Attach the air cleansing and deodorizing filters to the frame by gently compress its both sides and release after insertion into filter frame.

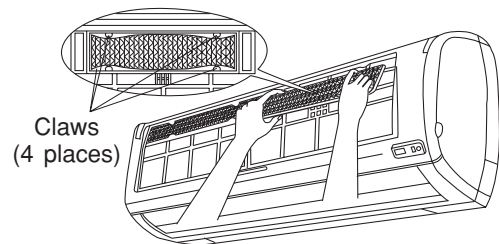

⚠ CAUTION

Do not bend the air cleansing and deodorizing filter as it may cause damage to the structure.

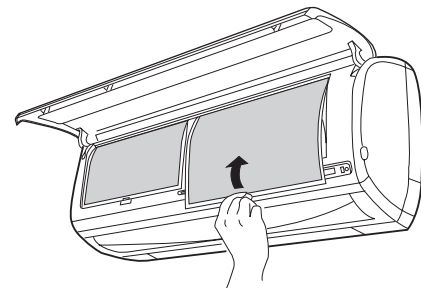

4 Attach the filters.

- Attach the filters by ensuring that the surface written "FRONT" is facing front.
- After attaching the filters, push the front panel at three arrow portion as shown in figure and close it.

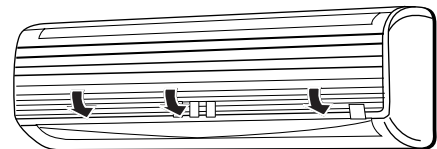

NOTE

- In case of removing the air cleansing and deodorizing filters, please follow the above procedures.
- The cooling capacity is slightly weakened and the cooling speed becomes slower when the air cleansing and deodorizing filters are used. So, set the fan speed to "HIGH" when using it in this condition.
- Air cleansing and deodorizing filters are washable and reusable up to 20 times by using vacuum cleaner or water rinse under running tap water. Type number for this air cleansing filter is <SPX-CFH5>. Please use this number for ordering when you want to renew it.
- Do not operate the air conditioner without filter. Dust may enter the air conditioner and fault may occur.

MAINTENANCE

⚠ CAUTION

Cleaning and maintenance must be carried out only by qualified service personal. Before cleaning, stop operation and switch off the power supply.

1. AIR FILTER

Clean the air filter, as it removes dust inside the room. In case the air filter is full of dust, the air flow will decrease and the cooling capacity will be reduced. Further, noise may occur. Be sure to clean the filter following the procedure below.

PROCEDURE

- 1 Open the front panel and remove the filter
 - Gently lift and remove the air cleansing and deodorizing filter from the air filter frame.

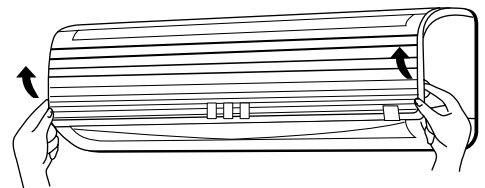

- 2 Vacuum dust from the air filter and air cleansing and deodorizing filter using vacuum cleaner. If there is too much dust, rinse under running tap water and gently brush it with soft bristle brush. Allow filters to dry in shade.

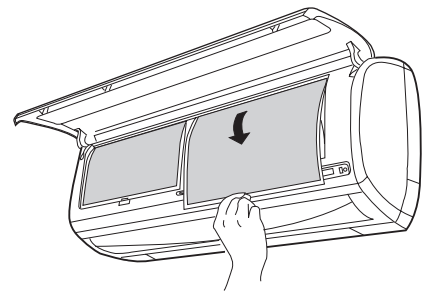
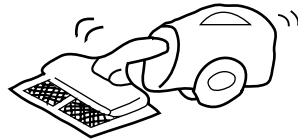

- 3
 - Re-insert the air cleansing and deodorizing filter to the filter frame. Set the filter with "FRONT" mark facing front, and slot them into the original state.
 - After attaching the filters, push the front panel at three arrow portions as shown in figure and close it.

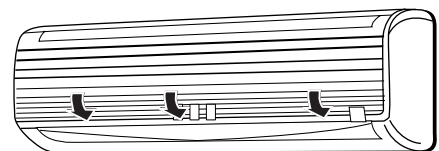

NOTE:

- Air cleansing and deodorizing filter should be cleaned every month or sooner if noticeable loading occurs. When used overtime, it may loose its deodorizing function. For maximum performance, it is recommended to replace it every 3-6 months depending on application requirements.

⚠ CAUTION

- Do not wash with hot water at more than 40°C. The filter may shrink.
- When washing it, shake off moisture completely and dry it in the shade; do not expose it directly to the sun. The filter may shrink.
- Do not use detergent on the air cleansing and deodorizing filter as some detergent may deteriorate the filter electrostatic performance.

2. Washable Front Panel

- Remove the front panel and wash with clean water.
Wash it with a soft sponge.
After using neutral detergent, wash thoroughly with clean water.
- When front panel is not removed, wipe it with a soft dry cloth. Wipe the remote controller thoroughly with a soft dry cloth.
- Wipe the water thoroughly.
If water remains at indicators or signal receiver of indoor unit, it causes trouble.

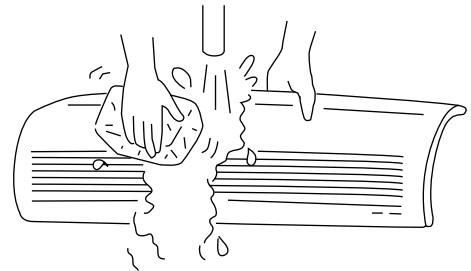

Method of removing the front panel.
Be sure to hold the front panel with both hands to detach and attach it.

Removing the Front Panel

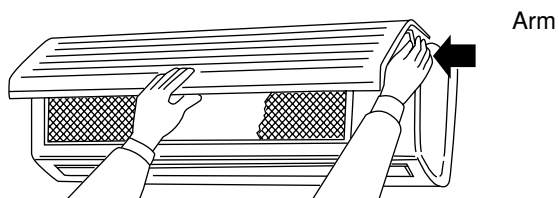

- When the front panel is fully opened with both hands, push the right arm to the inside to release it, and while closing the front panel slightly, put it out forward.

Attaching the Front Panel

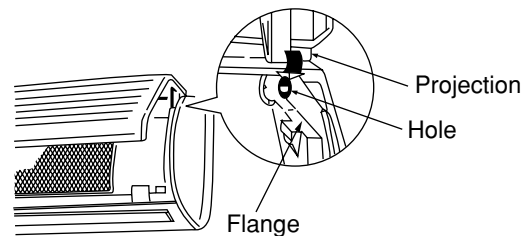

- Move the projections of the left and right arms into the **Flanges** in the unit and securely insert them into the holes.

CAUTION

- Do not splash or direct water to the body of the unit when cleaning it as this may cause short circuit.
- Never use hot water (above 40°C), benzine, gasoline, acid, thinner or a brush, because they will damage the plastic surface and the coating.



▲ CAUTION

Cleaning and maintenance must be carried out only by qualified service personal. Before cleaning, stop operation and switch off the power supply.

3. MAINTENANCE AT BEGINNING OF LONG OFF PERIOD

- Run the unit by setting the operation mode to ❄️ (COOL), the temperature to 32°C and the fan speed to HI for about half a day on a fine day, and dry the whole of the unit.
- Switch off the power plug.

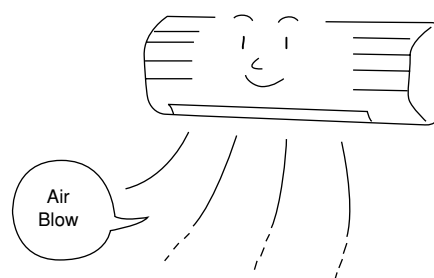

REGULAR INSPECTION

PLEASE CHECK THE FOLLOWING POINTS BY QUALIFIED SERVICE PERSONAL EITHER EVERY HALF YEARLY OR YEARLY. CONTACT YOUR SALES AGENT OR SERVICE SHOP.

1		Is the earth line disconnected or broken?
2		Is the mounting frame seriously affected by rust and is the outdoor unit tilted or unstable?
3		Is the plug of power line firmly plugged into the socket? (Please ensure no loose contact between them).

AFTER SALE SERVICE AND WARRANTY

WHEN ASKING FOR SERVICE, CHECK THE FOLLOWING POINTS.

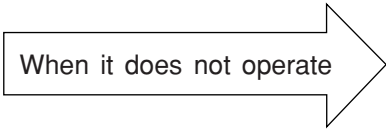
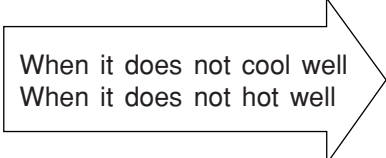
CONDITION	CHECK THE FOLLOWING POINTS
 <p>When it does not operate</p>	<ul style="list-style-type: none"> ● Is the fuse all right? ● Is the voltage extremely high or low? ● Is the circuit breaker "ON"?
 <p>When it does not cool well When it does not heat well</p>	<ul style="list-style-type: none"> ● Was the air filter cleaned? ● Does sunlight fall directly on the outdoor unit? ● Is the air flow of the outdoor unit obstructed? ● Are the doors or windows opened, or is there any source of heat in the room? ● Is the set temperature suitable?



Notes

- In quiet operation or stopping the operation, the following phenomena may occasionally occur, but they are not abnormal for the operation.
 - (1) Slight flowing noise of refrigerant in the refrigerating cycle.
 - (2) Slight rubbing noise from the fan casing which is cooled and then gradually warmed as operation stops.
- The odor will possibly be emitted from the room air conditioner because the various odor, emitted by smoke, foodstuffs, cosmetics and so on, sticks to it. So the air filter and the evaporator regularly must be cleaned to reduce the odor.

- Please contact your sales agent immediately if the air conditioner still fails to operate normally after the above inspections. Inform your agent of the model of your unit, production number, date of installation. Please also inform him regarding the fault.
- Power supply shall be connected at the rated voltage, otherwise the unit will be broken or could not reach the specified capacity.

Please note:

On switching on the equipment, particularly when the room light is dimmed, a slight brightness fluctuation may occur. This is of no consequence.
The conditions of the local Power Supply Companies are to be observed.

NOTE:

If the supply cord is damaged, it must be replaced by the special cord obtainable at authorized service parts centers.

Note

- Avoid to use the room air conditioner for cooling operation when the outside temperature is below 21°C (70°F).
The recommended maximum and minimum operating temperatures of the hot and cold sides should be as below:

		Minimum	Maximum
Indoor	Dry bulb °C	21	32
	Wet bulb °C	15	23
Outdoor	Dry bulb °C	21	43
	Wet bulb °C	15	26

CONSTRUCTION AND DIMENSIONAL DIAGRAM

MODEL RAS-18G4

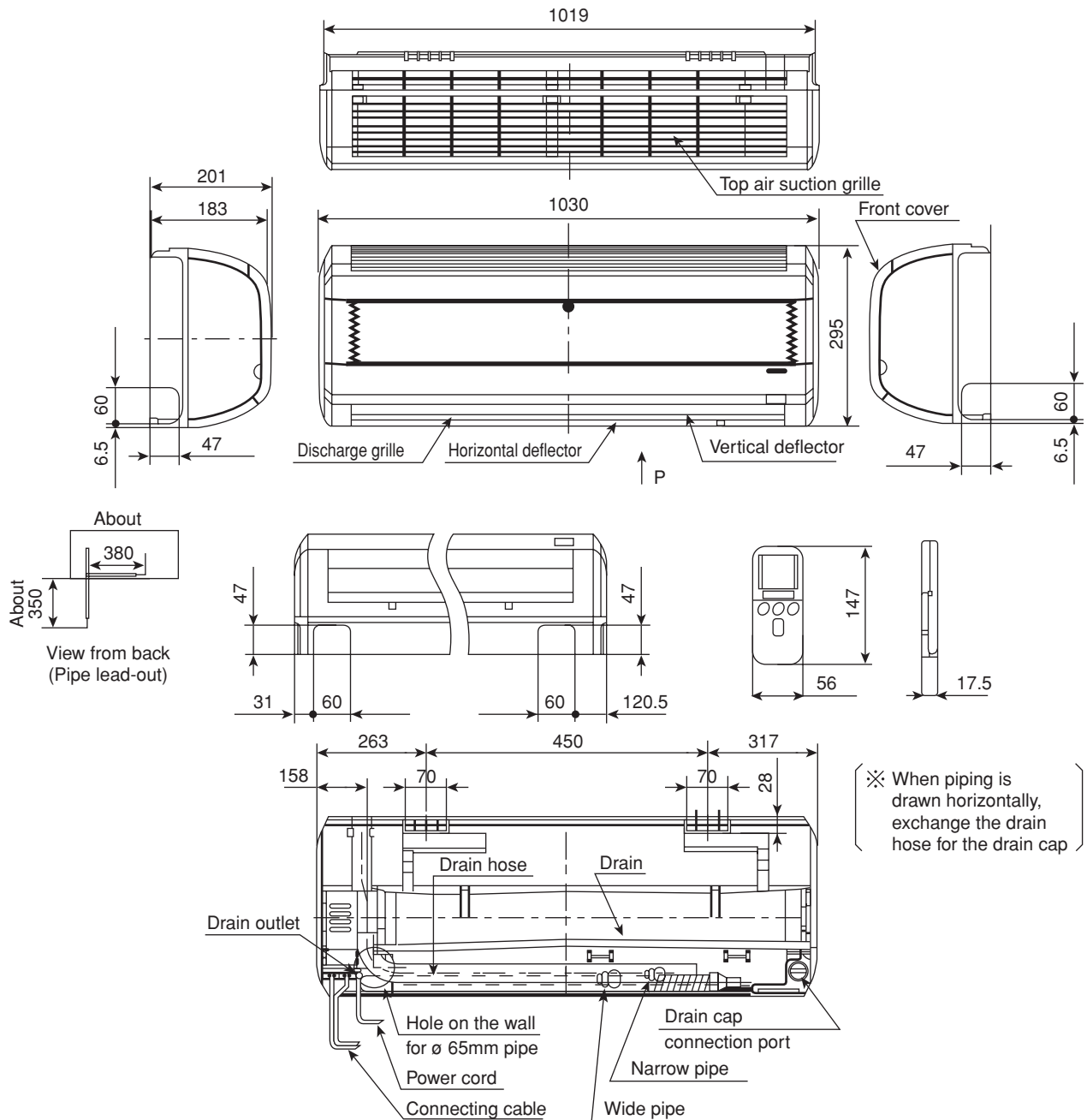

Note:

1. Servicing space of 100mm or more is required on the left and right sides of the indoor unit and also 50mm or more space is required above the unit
2. Insulated pipes should be used for both the narrow and wide dia. pipes.
3. Piping length is within 15m
4. Height different of the piping between the indoor unit and the outdoor unit should be within 5m.
5. Power supply cord length is about 2m
6. Connecting cord 2.5mm² dia. x 3 is used for connection.

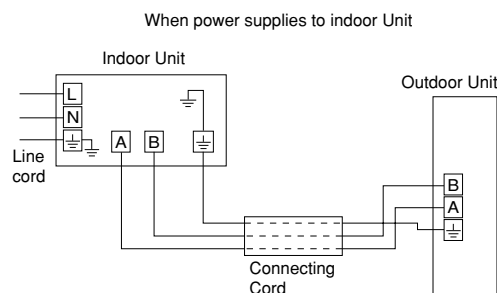

MODEL RAC-18G4

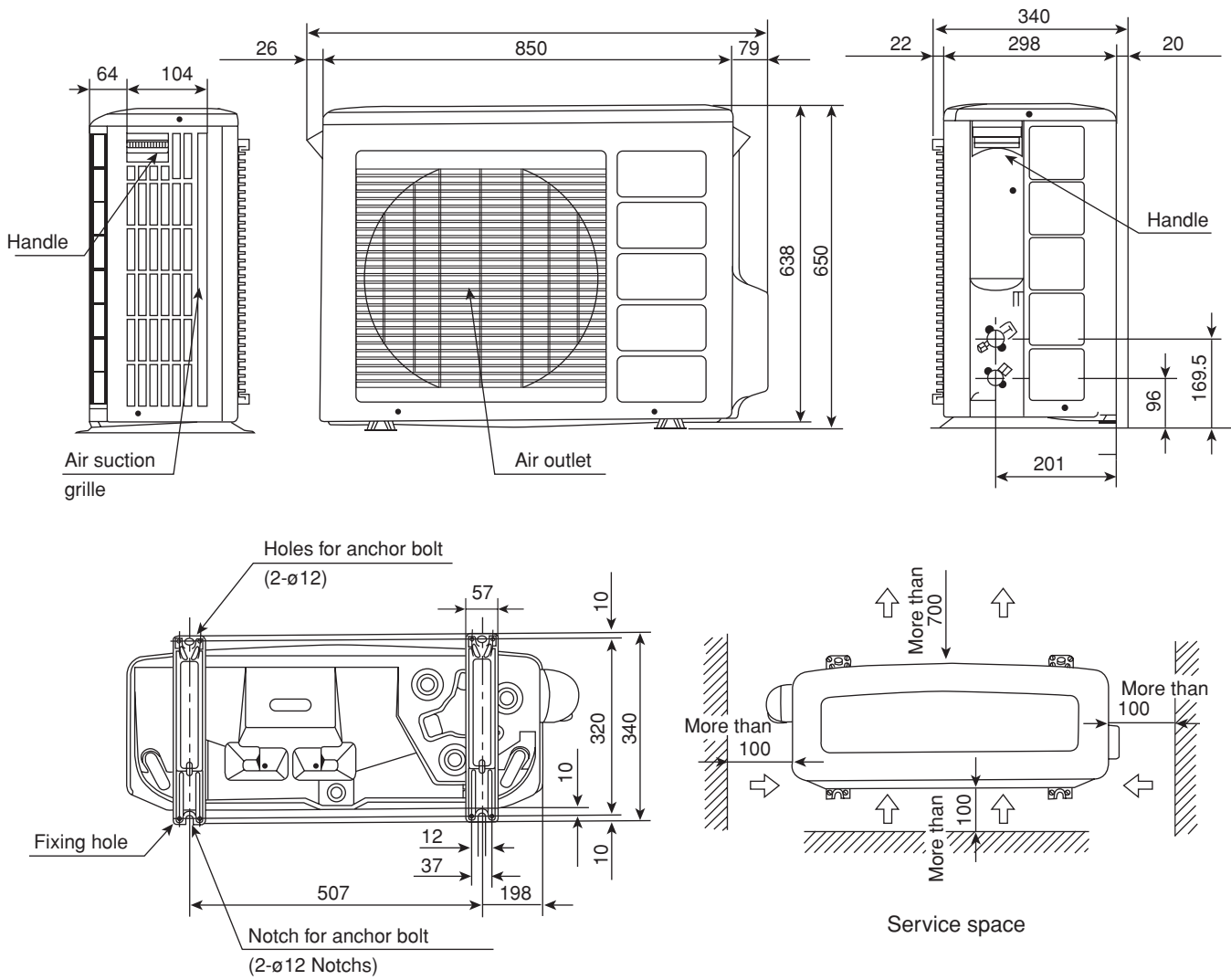

Note:

1. 200mm or more servicing space is required above the outdoor unit.

MAIN PARTS COMPONENT

THERMOSTAT (Room Temperature Thermistor)

Thermostat Specifications

MODEL			RAS-18G4
THERMOSTAT MODEL			IC
OPERATION			COOL
TEMPERATURE °C	INDICATION 16	ON	17.6 (63.7)
		OFF	17.3 (63.1)
	INDICATION 24	ON	25.6 (78.1)
		OFF	25.3 (77.5)
	INDICATION 32	ON	33.6 (92.5)
		OFF	33.3 (91.9)

FAN MOTOR

Fan Motor Specifications

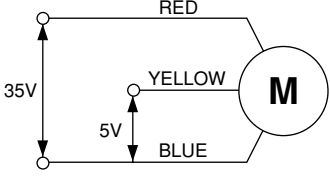
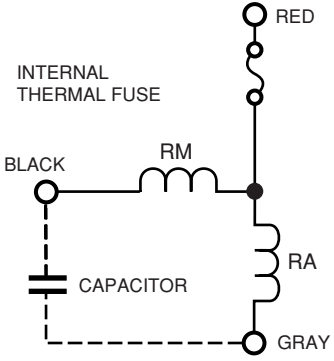
MODEL		RAS-18G4	RAC-18G4
PHASE		-----	SINGLE
RATED VOLTAGE		DC35V	220-240V
RATED FREQUENCY		-----	50 Hz
OUTPUT		30 W	40 W
POLE NUMBER		-----	6
CONNECTION			
RESISTANCE VALUE (Ω)	20°C	-----	RM = 122.4 RA = 114.8
	75°C	-----	RM = 161.6 RA = 139.6

COMPRESSOR MOTOR

Compressor Motor Specifications

MODEL	RAC-18G4	
COMPRESSOR MODEL	5KS205DAA	
PHASE	SINGLE	
RATED VOLTAGE	220 ~ 240 V	
RATED FREQUENCY	50 Hz	
LOCKED ROTOR CURRENT	26.0 ~ 28.0	
POLE NUMBER	2	
CONNECTION		
RESISTANCE VALUE (Ω)	20°C (68°F)	RM = 1.780 RA = 2.175
	75°C (167°F)	RM = 2.16 RA = 2.64
EXTERNAL OVERLOAD RELAY	NO	
INTERNAL PROTECTOR	YES	

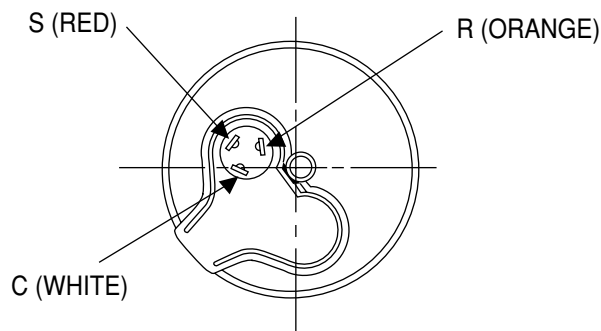

RAC-18G4

CAUTION

When the Air Conditioner has been operated for a long time with the capillary tubes clogged or crushed or with too little coolant, check the color of the refrigerant oil inside the compressor. If the color has been changed conspicuously, replace the compressor.

WIRING DIAGRAM

MODEL RAS-18G4/RAC-18G4

- | | | |
|--|----------------------|--------------------------|
| (A) : COMPRESSOR | (J) : TERMINAL BOARD | (S) : ROOM THERMISTOR |
| (B) : FAN MOTOR | (K) : LINE CORD | (T) : HEX THERMISTOR |
| (C) : POWER SWITCH | (N) : NOISE FILTER | (U) : INTERNAL PROTECTOR |
| (D) : THERMAL FUSE FOR 2P TERMINAL (102°C) | (P) : POWER RELAY | (V) : VARISTOR |
| (E) : THERMAL FUSE FOR P.C.B. (96°C) | (R) : SURGE ABSORBER | (X) : FUSE |
| (G) : 50 μF CAPACITOR | | (Z) : AUTO SWEEP MOTOR |
| (H) : 2.5 μF CAPACITOR | | |

BLU : BLUE
 GRN : GRAY
 BLK : BLACK

YEL : YELLOW
 ORN : ORANGE
 PNK : PINK

BRN : BROWN
 GRN : GREEN
 VIO : VIOLET

WHT : WHITE
 RED : RED
 IVO : IVORY

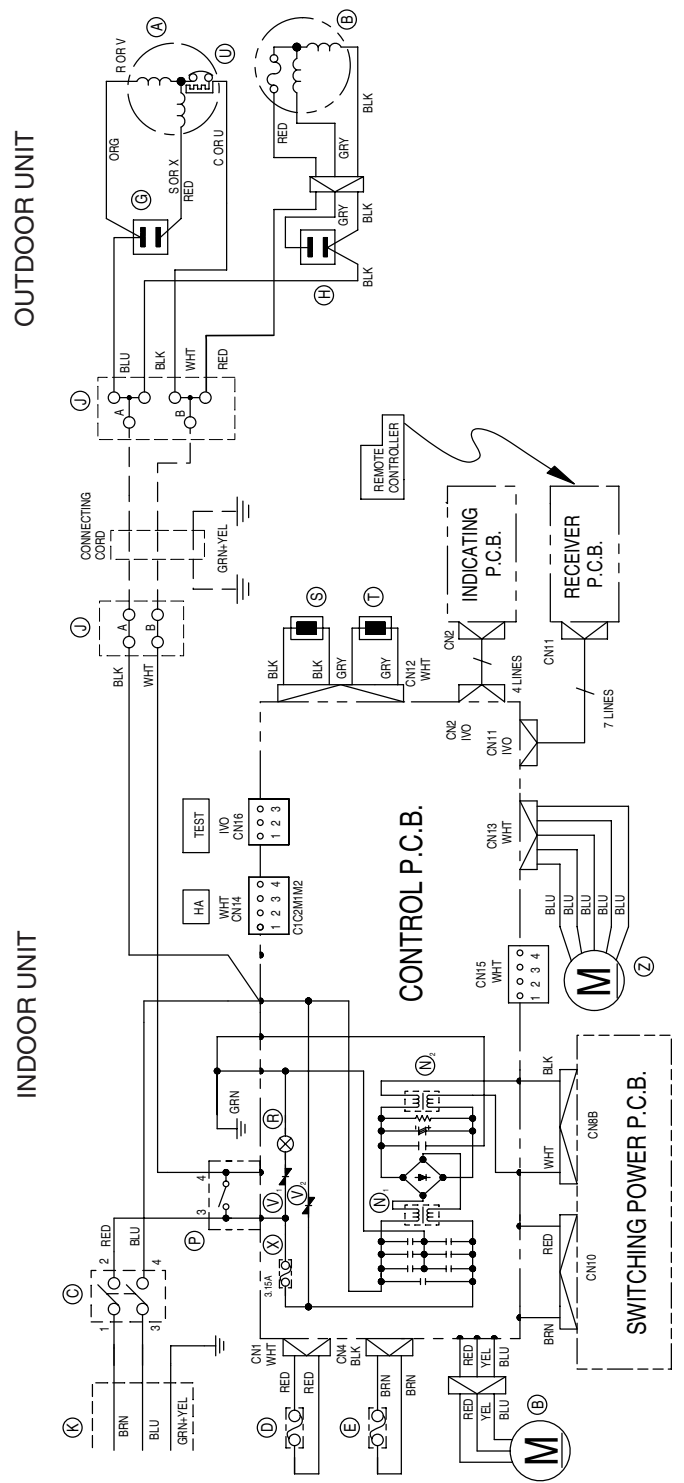

CIRCUIT DIAGRAM

Remote Control

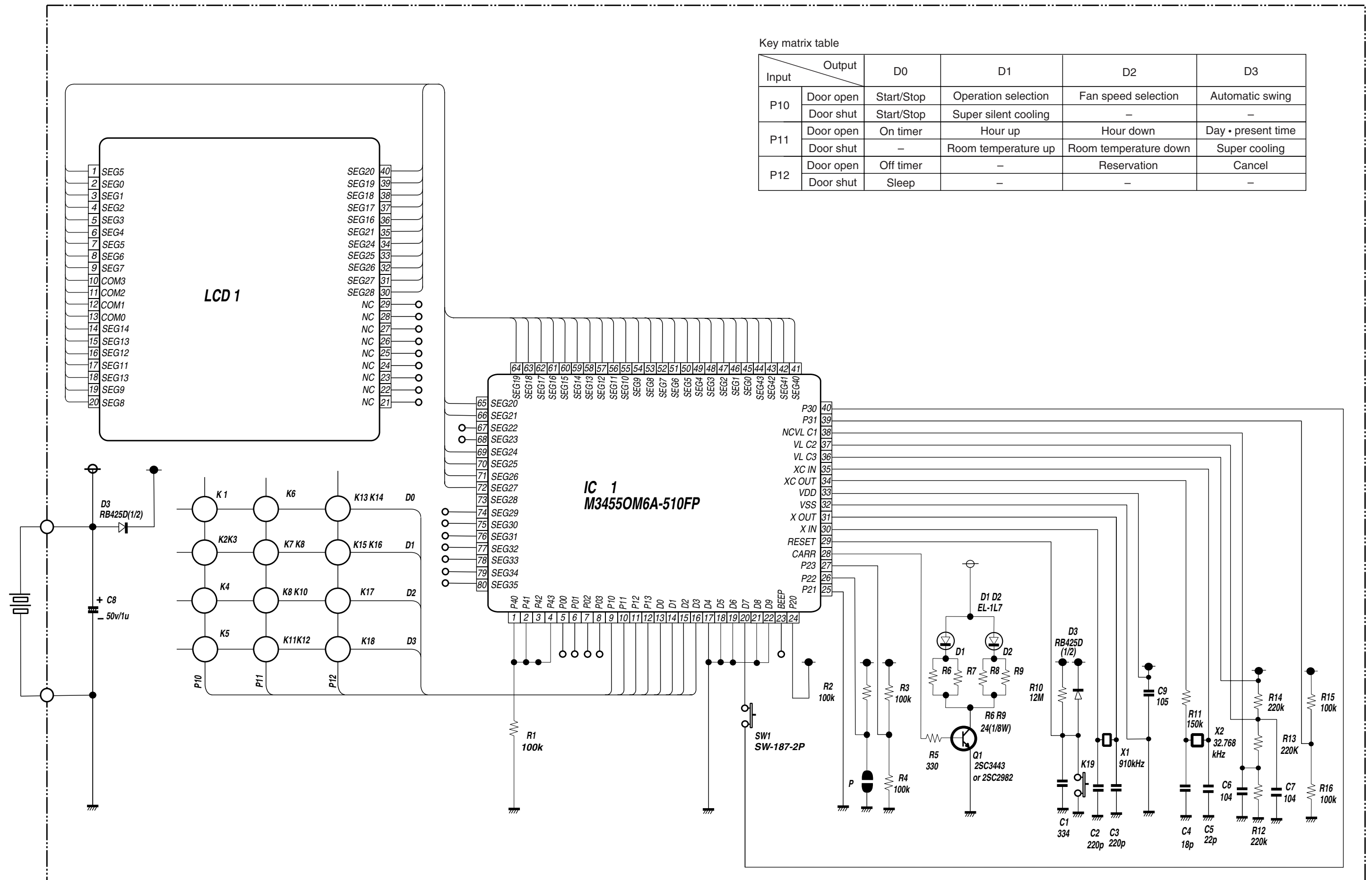

Key matrix table

		Output	D0	D1	D2	D3
P10	Door open	Start/Stop	Operation selection	Fan speed selection	Automatic swing	
	Door shut	Start/Stop	Super silent cooling	–	–	
P11	Door open	On timer	Hour up	Hour down	Day • present time	
	Door shut	–	Room temperature up	Room temperature down	Super cooling	
P12	Door open	Off timer	–	Reservation	Cancel	
	Door shut	Sleep	–	–	–	

BLOCK DIAGRAM
MODEL RAS-18G4/RAC-18G4

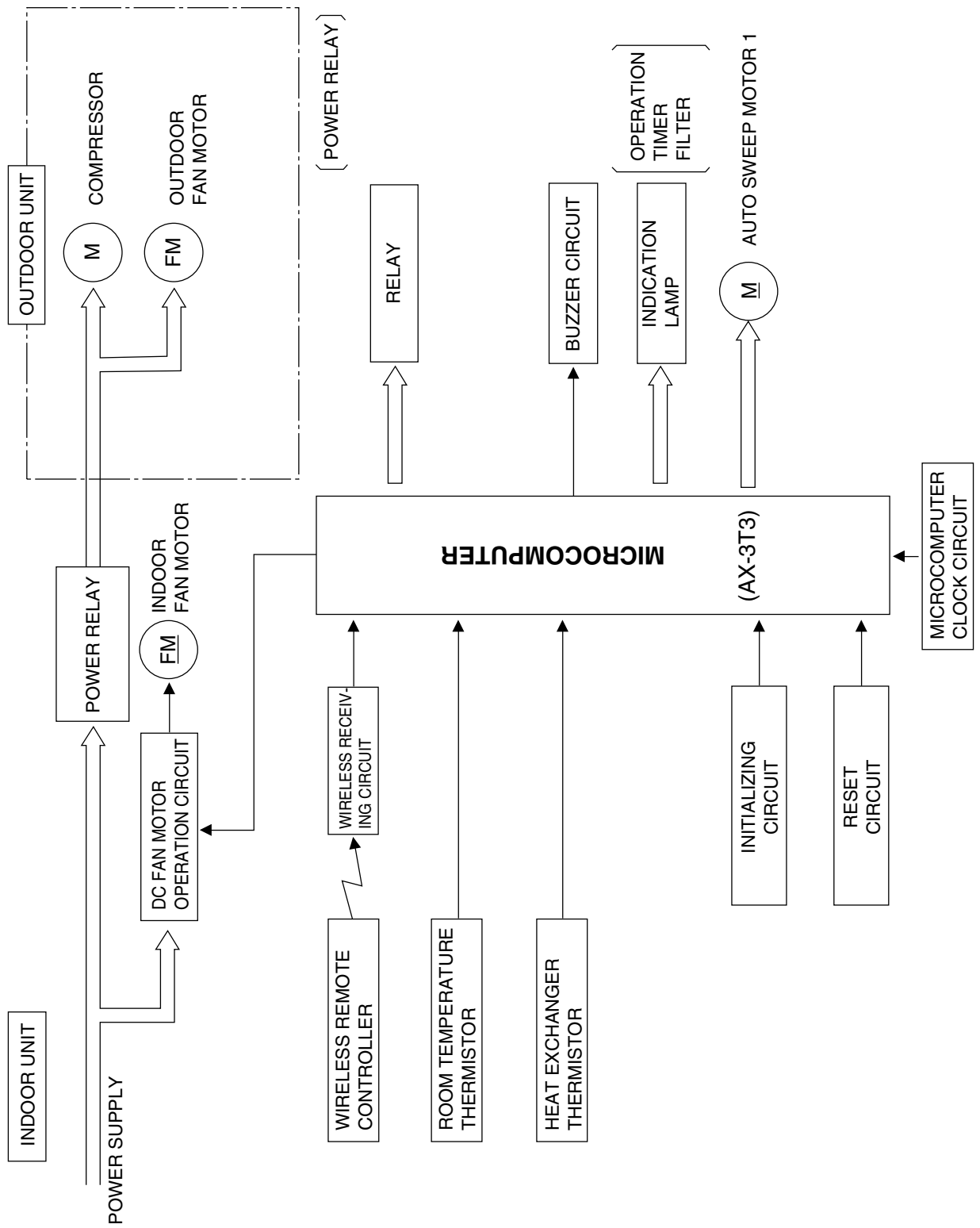

BASIC MODE

MODEL RAS-18G4/RAC-18G4

No.	Operation mode	Fan	Cooling	Sensor dehumidification	Circulation	Automatic			
1	ON / OFF switch, basic mode			<p>ON / OFF switch Operation lamp</p> <p>Operation and stop are repeated independent of timer reservations</p>					
2	Timer operation	OFF timer		<p>ON / OFF switch Reservation Cancel + Operation lamp Timer lamp Timer memory</p> <p>(OFF timer during stop) (Cancel) (Change of the reservation time)</p>	<p>* Both operation lamp and Dry lamp light during Sensor dehumidification at operation mode.</p>				
		ON timer		<p>ON / OFF switch Reservation Cancel + Operation lamp Timer lamp Timer memory</p> <p>(ON timer during operation) (Cancel) (Change of the reservation time)</p>					
		OFF ⇄ ON timer		<p>ON / OFF switch Reservation Cancel + Operation lamp Timer lamp Timer memory</p> <p>(OFF -> ON timer) (ON -> OFF timer) (ON -> OFF timer during operation) (OFF -> ON timer during stop)</p>					
3	Fan speed mode	Automatic	<ul style="list-style-type: none"> • "HI", "MED", or "LO" operation is executed according to the thermostat signal. (Refer to "Thermostat operation".) 	<ul style="list-style-type: none"> • "LO" and "Stop" are repeated according to the thermostat signal, independent of the setting. 	<ul style="list-style-type: none"> • Repetition of "HI" and "Stop" by means of thermo signal and time. • Repetition of "MED" "Stop" by means of thermo signal and time. • Repetition of "LO" "Stop" by means of thermo signal and time. 	<ul style="list-style-type: none"> • The "Automatic" speed mode for each operation mode is used independent of the setting. ("LO" at the time of "Sensor dehumidification".) 			
		HI	<ul style="list-style-type: none"> • Operation in "HI" mode • Same as on the left. 						
		MED	<ul style="list-style-type: none"> • Operation in "MED" mode • Same as on the left. 						
		LO	<ul style="list-style-type: none"> • Operation in "LO" mode • Same as on the left. 						
4	Thermostat operation H → HI M → MED L → LO	<ul style="list-style-type: none"> • Only circulation with cut velocity is executed, independent of the thermostat signal. 	<p>(1) In case of "Automatic" mode</p> <p>Set temperature</p> <p>ON / OFF Switch Fan Speed H Fan Speed M Fan Speed L Power relay Stick relay Operation lamp</p> <p>2 sec → 2 sec → 2 sec → 2 sec</p> <p>H L M L M H L</p>	<p>(1) When the set temperature is lower than the room temperature.</p> <p>Set temperature</p> <p>ON / OFF Switch Fan Speed L Power relay Stick relay Operation lamp Dry lamp</p> <p>30 sec 30 sec</p> <p>2 sec → 2 sec → 2 sec</p> <p>L L L</p>	<p>Room temperature ↑ at the start of operation ↓</p> <table border="1"> <tr> <td>Cooling</td> <td>The set temperature shall be 27°C.</td> </tr> <tr> <td>Sensor dehumidification</td> <td>The set temperature shall be 2 degrees below the room temperature at the start of operation.</td> </tr> </table> <p>Notes</p> <ul style="list-style-type: none"> • A shift is not accepted at the time of operation start. • There is no switching between modes after start of operation. • When the operation is started again within 20 hours after stop with the ON / OFF button, operation will be executed in the previous mode. • The operation details are the same as for each operation mode. • The set temperature is set with the room temperature adjustment button. Correction by V, ±3°C is possible with. At this time, the operation mode judgement temperature also is shifted at the same time. However, correction is possible only in cooling operation mode, but not in "Sensor dehumidification" mode. <p>Set temperature</p> <p>ON / OFF Switch Fan Speed L Power relay Stick relay Operation lamp Dry lamp</p> <p>30 sec 30 sec</p> <p>2 sec → 2 sec</p> <p>L L L</p>	Cooling	The set temperature shall be 27°C.	Sensor dehumidification	The set temperature shall be 2 degrees below the room temperature at the start of operation.
		Cooling	The set temperature shall be 27°C.						
Sensor dehumidification	The set temperature shall be 2 degrees below the room temperature at the start of operation.								
<ul style="list-style-type: none"> • The power relay is delayed by 2 seconds from the start of thermostat. 	<p>(2) In other modes than "Automatic" Same as above (but operation is made with the velocity set at the time of operation start).</p> <p>Note:</p> <ul style="list-style-type: none"> • The min. ON time of the power relay is 3 minutes, and the min. OFF time also is 3 minutes. <p>(2) Set temperature is higher than room temperature.</p> <p>Notes:</p> <ul style="list-style-type: none"> • Forced operation by ON / OFF button ON is executed even with thermostat OFF. • The room temperature 30 sec after operation start, minus 0.66 deg, becomes the set temperature. • When the room temperature is 16°C or lower, 16°C becomes the set temperature. • The other operations are the same as for (1). 								

No.	Operation mode Control function	Fan	Cooling	Sensor dehumidification	Circulation	Automatic	
5	<p>Sleep mode</p> <ul style="list-style-type: none"> The set temperature after sleep shift in sensor dehumidification operation is limited by 16°C. 	<ul style="list-style-type: none"> The operation is switched OFF at the set time. 	<p>The diagram shows a sequence of events over time. A vertical line marks the start of the timer. At this point, the 'Set temperature ON / OFF Switch' turns ON. A horizontal arrow labeled '60 minutes' indicates the duration of the timer. At the end of this 60-minute period, the 'Set temperature' shifts up by '2 deg up'. Simultaneously, 'Timer reservation' turns ON, 'Sleep mode' turns ON, and the 'Operation lamp' and 'Timer lamp' both turn ON. A horizontal arrow labeled 'Low (sleep operation)' spans from the start of the timer to the end of the 60-minute period, indicating the duration of sleep operation.</p>			<ul style="list-style-type: none"> The operation is switched OFF at the set time. 	<ul style="list-style-type: none"> Sleep operation is executed for each operation mode.
			<p>Notes:</p> <ul style="list-style-type: none"> 60 minutes after the sleep key is switched on, sleep operation is started. When the sleep key is switched on during OFF timer operation, the OFF timer will be canceled. The sleep operation is started when the sleep key is "ON" after timer reservation. 				

6 "NICE TEMPERATURE" reservation

- Operation starts in advance so that the room temperature reaches the preset value at the set time.
- The operation time is obtained as follows depending on the room temperature when operation starts.

(1) Calculation method of the moved-up time.
 Moved-up time (MT) = Moved-up time depending on the temperature difference (OT) + compensation time (HT).
 MT is at least 5 minute if OT is not zero.

	Cooling
(MT)	00 ~ 60 min.
(OT)	00 ~ 60 min.
(HT)	-60 ~ 60 min.

Obtain OT (moved-up time depending on the temperature difference) from the table below.

Cooling			
Setting temp.	Room temp.	Time (min.)	
00.00	02.00	00	
02.25	05.00	15	
05.25	08.00	30	
08.25	11.00	45	
11.25		60	

* The preset temperature value shown above does not include any shift value.

(2) Compensation

- ① The "Attained" state is monitored and a "Not attained" check is done to revise the compensation time (HT).

<p>"Attained" monitor</p> <p>Continuously monitored during "NICE TEMPERATURE" operation.</p> <p>(Cooling)</p> <p>When the room temperature < Set value + compensation shift, it is regarded to be "attained" and 5 minutes are reduced from the cooling compensation time.</p>
<p>"Not attained" check</p> <p>Performed once when the "NICE TEMPERATURE" timer is completed.</p> <p>(Cooling)</p> <p>When the room temperature > Set value + compensation shift +1°C, it is regarded to be "Not attained" and 5 minutes are added to the cooling compensation time.</p>
<p>* If the room temperature is within +1°C from the set value + compensation shift, compensation is not done.</p>

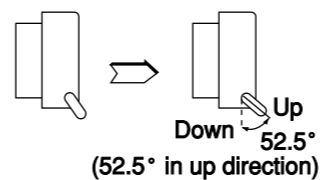
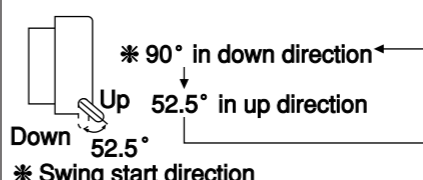
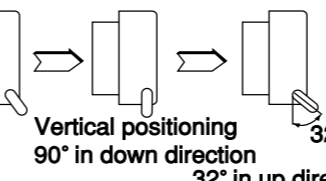
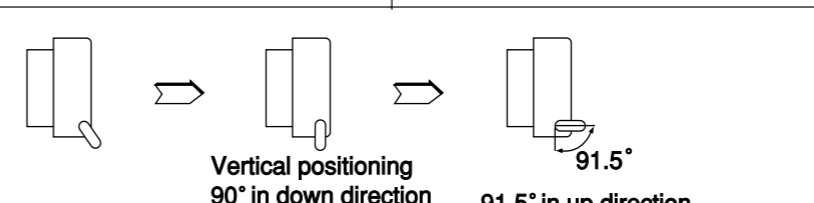
Item	Specification	
	3-way	AUTO (Swing)
Cooling/dehumidifying		
Circulator		The same as cooling • dehumidifying
(When the operation switch is turned off after the filter sign lamp lights.)		

- The air deflector control operation shown below is done when the swing switch is pressed or when the operation mode is changed.
- The air deflector control operation shown below is done when the operation switch is turned off after the filter sign lamp is lit.

Other detailed specifications

1. When the room temperature starts to increase within 3 minutes after thermo OFF in "cooling" and fan speed "AUTO", the fan speed changes L → M → H as when thermo ON.
2. If "cooling" is selected during "sensor dehumidification" operation the operation continues as it is with the thermo ON. The 3 minutes delay is not started. The set temperature and fan speed depend on the remote control signal. It is same for "cooling" --- "sensor dehumidification". It is same for "AUTO" sensor dehumidification cooling "sensor dehumidification" "cooling".
3. The filter sign lights after 200 hours operation of the room fan. The time is cleared when power switch set to OFF and ON again.
4. After the failure mode is started (indicator lamp flickering), rapid mode changing cannot be done.
5. If the operation is made by the nice temperature reservation during the sleep operation, the normal operation continuously occurs, and for the advance time, the temperature difference between the set temperature without sleep shift and "room temperature" is used.

Table 1 Specifications

Item	RAS-18G4	
Operation switching	Automatic	Yes
	Circulator	Yes
	Sensor dehumidification	Yes
	Cooling	Yes
	Fan	Yes
Temporary switch	Yes (automatic)	
Service switch	Cooling	Yes
Nice temperature reservation	Yes	
Defrosting	No	
Sleep circuit	Yes	
Heater operation at the time of sensor dehumidification	No	
Automatic blowing direction	Yes	
Filter sign	Yes	
Wireless mode	Cooling	

Table 2 Sensor operation values

Item	RAS-18G4			
Thermostat operation	ON temperature (Thermostat relay) power relay (°C)	Cooling, sensor dehumidification	16	17.6
			24	25.6
			32	33.6
	Differential (°C)			0.33
Low-temperature defrosting	(T1)	ON (°C)	4.0	
		Reset (°C)	12.0	

REFRIGERATING CYCLE DIAGRAM

MODEL RAS-18G4/RAC-18G4

COOLING, DEHUMIDIFYING, DEFROSTING

OUTDOOR UNIT

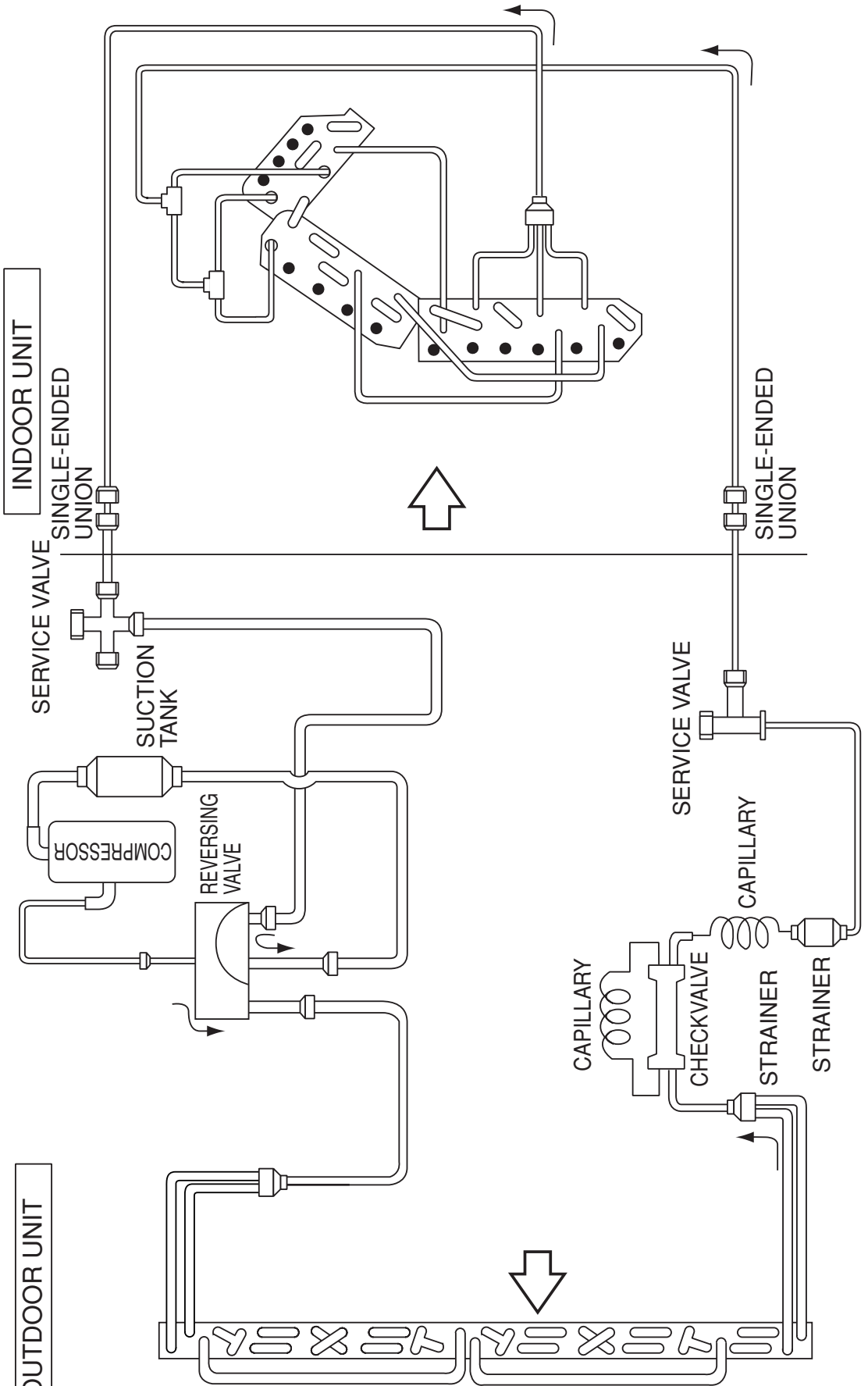

DESCRIPTION OF MAIN CIRCUIT OPERATION

1. ON / OFF

The "ON / OFF" and "Timer reserve button" and "Sleeping" function independently. Their operations are shown in Fig. 1-1.

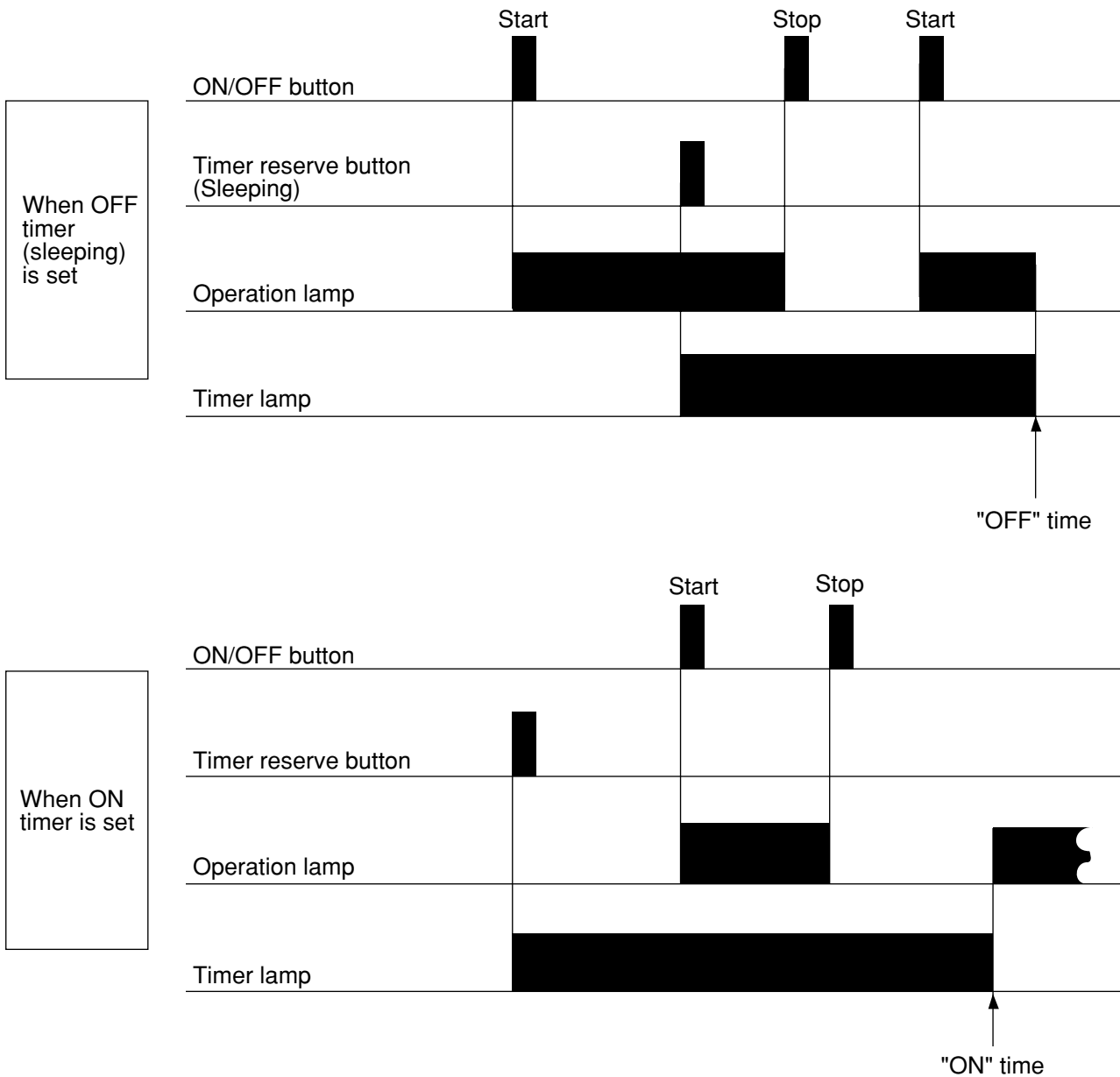
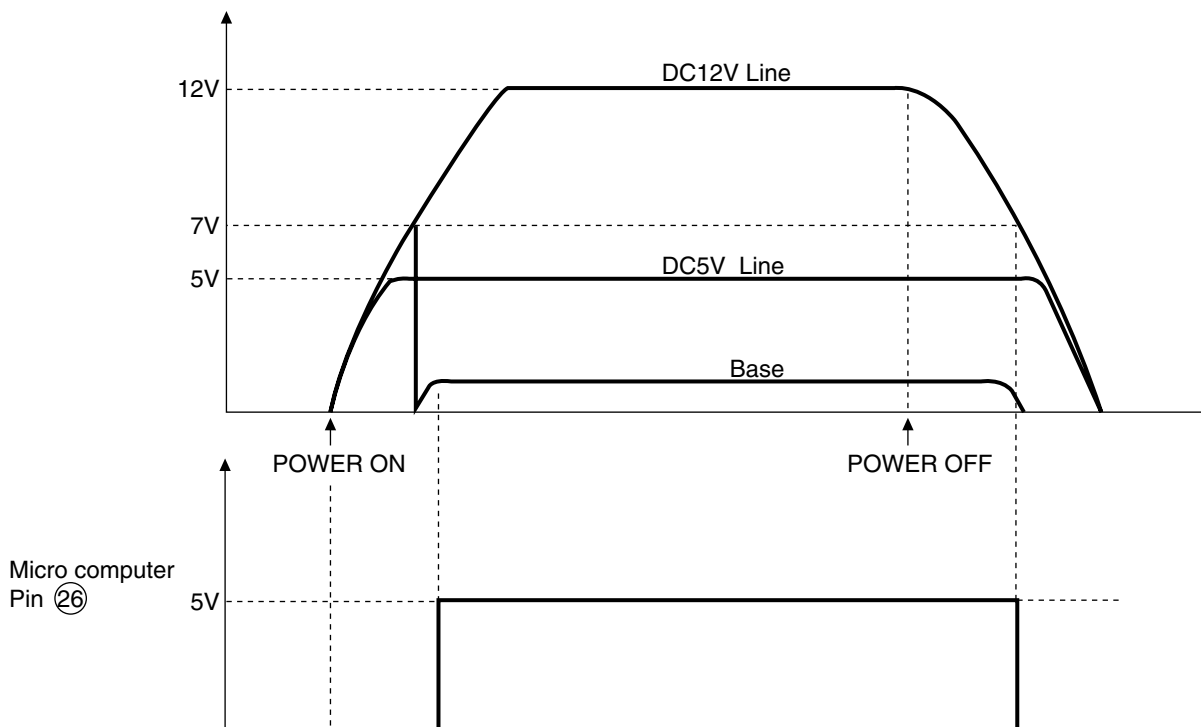
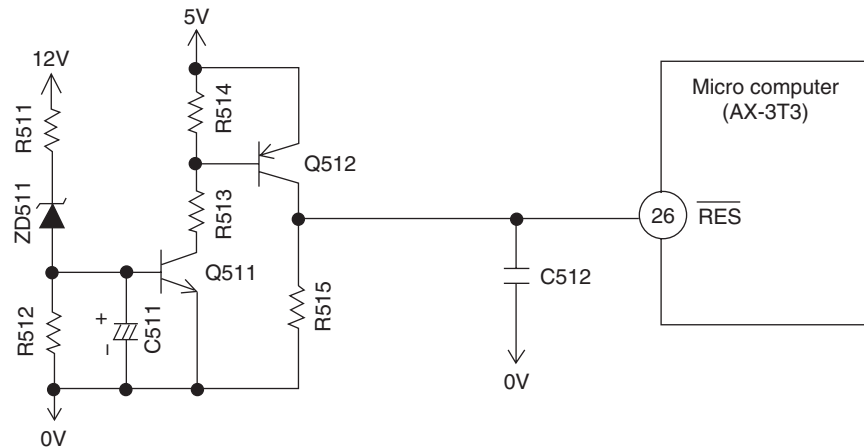

Fig. 1-1 Timer operation

2. Reset Circuit



- The reset circuit is used to reset the program to its initial settings when the power is turned on or when the power is recovered after a power failure.
- The micro computer is reset when the reset input is “Hi”, and operation is possible when the reset input is “Lo”.
- The waveforms at each point when the power is turned on and off are shown in the diagrams.
- When the power is turned on, the voltages of the DC 12V line and DC 5V lines are increased. When the voltage of DC 12V lines reaches about 7V, ZD511 is turned ON, the potential of Q511’s base rises and Q511 is turned ON. Since Q511’s collector is set to “LO” at this time, Q512 is turned OFF and the reset input of the micro computer is set to “Lo”. The DC 5V line voltage has already become 5V at this time and the micro computer starts operation.
- When the power is turned OFF, the voltage of the DC 12V line decreases. When it becomes about 7V, ZD511 is turned OFF, then Q511 is turned OFF, Q512 is turned ON the reset input of the micro computer is set to “Hi” and the micro computer is set to the reset mode.

3. Buzzer Circuit

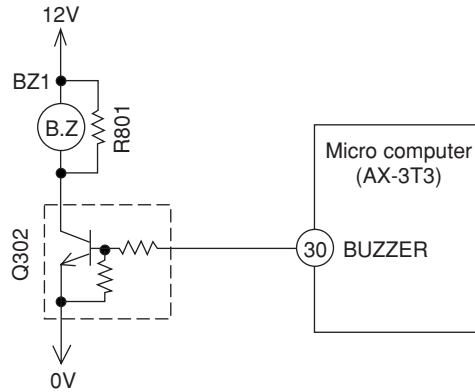

When the buzzer is to be activated, buzzer output pin ⑩ of the micro computer alternates between ON and OFF repeatedly at 4kHz and Q302 is turned ON/OFF accordingly. A 4kHz voltage is applied to the buzzer and the diaphragm of the buzzer vibrates to output 4kHz sound.

4. Initial setting (IC301)

The pre-heating operation start value, ratings of the compressor, maximum rotation speed, etc. are preset in the micro computer.

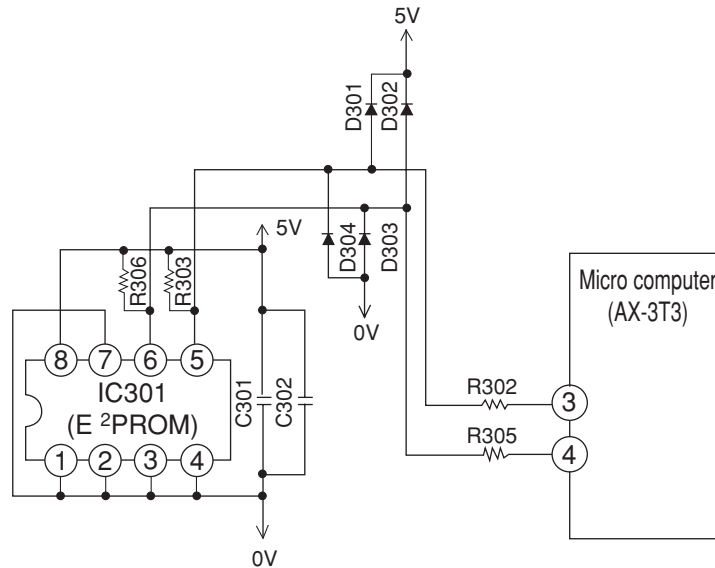

5. Receive circuit

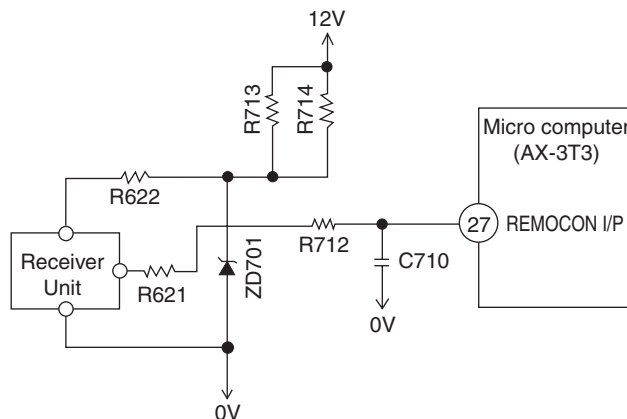

Infrared signals from the wireless remote controller are received by the light receiving unit and output after being amplified and shaped.

6. Service Operation Circuit

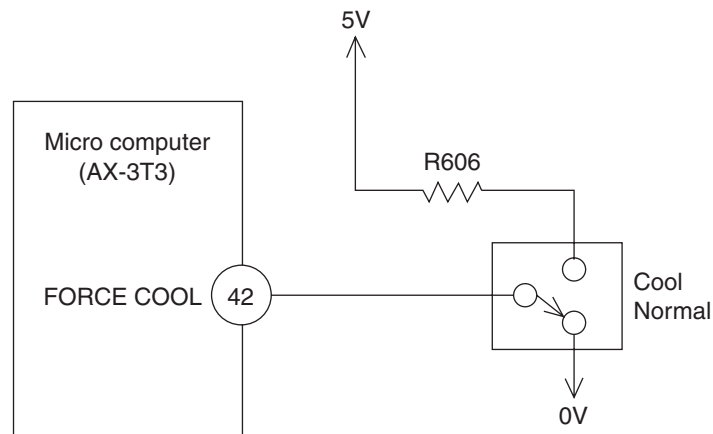

- Use the service switch to select “Cooling” temporarily when the interior electric equipment has troubled.
- Setting the switch to “Cooling” causes continuous cooling room temperature control. To control the room temperature, turn on and off the disconnect switch. To protect the compressor, wait at least 3 minutes before turning on again.
- The fan speed is “MED”.
- Does not operate if 12V is not generated in the control circuit.
- When the service switch is used for operation, each change switch is overridden.
- Setting the service switch to “Cooling” turns on the “Power relay”.

AUTO SWING FUNCTION

INPUT SIGNAL	PRESENT CONDITION		OPERATING SPECIFICATION	REFERENCE
	OPERATION	OPERATION MODE AIR DEFLECTOR		
KEY INPUT	STOP	EACH MODE	ONE SWING (CLOSING AIR DEFLECTOR) ① DOWNWARD ② UPWARD	INITIALIZE AT NEXT OPERATION.
	DURING OPERATION	AUTO COOL COOL FAN AUTO DRY DRY	STOP AT THE MOMENT. START SWINGING ① DOWNWARD ② UPWARD ③ DOWNWARD	
INTERNAL FAN ON (THERMO. ON)	DURING OPERATION	CIRCULATOR	STOP	START SWINGING ① DOWNWARD ② UPWARD ③ DOWNWARD
			DURING SWINGING	STOP AT THE MOMENT.
INTERNAL FAN OFF (THERMO. OFF)	DURING OPERATION	AUTO DRY DRY CIRCULATOR	TEMPORARY STOP	START SWING AGAIN.
			DURING SWINGING	STOP SWINGING TEMPORARILY. (SWING MODE IS CLEARED IF SWING COMMAND IS TRANSMITTED DURING TEMPORARY STOP.)
MAIN SWITCH ON	STOP	COOL FAN DRY	INITIALIZE ① DOWNWARD ② UPWARD	
		CIRCULATOR	INITIALIZE ① DOWNWARD	
MAIN SWITCH OFF	DURING OPERATION	EACH MODE	ONE SWING (CLOSING AIR DEFLECTOR) ① DOWNWARD ② UPWARD	INITIALIZE AT NEXT OPERATION.
			INITIALIZING CONDITION OF EACH MODE. STOP SWINGING AND MODE BECOMES INITIALIZING CONDITION.	
CHANGE OF OPERATION	DURING OPERATION	EACH MODE	STOP	
			DURING SWINGING	

SERVICE CALL Q & A

Cooling operation

Q1 While cooling, the compressor sometimes stops abruptly.

A1 Check whether frost sticks on the heat exchanger of indoor unit or not.
Wait for 3 – 4 minutes until the frost melts.

If cooling is performance when the room temperature is low, frost may stick on the heat exchanger of indoor unit.

Dehumidifying operation

Q2 The fan speed does not change during a dehumidifying operation.

A2 The fan speed is always LO at a dehumidifying operation.

Q3 Cold air comes out during a dehumidifying operation.

A3 To improve the dehumidification efficiency, LO fan speed operation is performed. Therefore the air is cold. This is not a trouble.

Q4 The operation does not stop even by raising the room temperature setting of remote control at a dehumidifying operation.

A4 At a dehumidifying operation, the actual room temperature is compared with the room temperature setting when starting the operation and the operation is as follows.

1) When actual room temperature > room temperature setting.

The operation is according to the room temperature setting on the remote controller.

2) * When actual room temperature < room temperature setting

Regardless of the room temperature setting, the temperature is automatically set slightly lower than the room temperature.

In this case, the status is as 2) and, therefore, the operation by the room temperature control is impossible. Turn off the On / OFF switch, set the room temperature to a new value and turn on the operation by the On / Off switch.

Q5 In the dehumidifying mode, the temperature set by remote controller is set slightly higher than the room temperature but the operation starts.

A5 This is the status in 2) of (A4). The temperature is set a little lower than the room temperature to carry out a dehumidifying operation as far as possible.

Automatic operation

Q6 How is the automatic operation mode determined?

A6 According to the room temperature, cooling or dehumidifying operation is automatically selected.

Cooling:

When room temperature is approx. 27°C or higher

Dehumidifying:

When room temperature is between approx. 23°C and 27°C

Q7 At an automatic operation, changing the fan speed change switch does not vary the fan speed.

A7 The fan speed is automatically determined.

Q8 The room temperature cannot be controlled at an automatic operation.

A8 It is automatically set as follows.

At cooling: Set at 27°C

At dehumidifying:

Set slightly lower than room temperature

The room temperature setting can be raised 3°C by "Λ" or lowered 3°C by "V".

When changing the room temperature setting in an automatic operation, the next automatic operation mode is determined by new room temperature setting. If, for example, the room temperature setting is 2°C lowered for example, the operation mode is as follows.

Cooling : When room temperature is approx. 25°C or higher

Dehumidifying : When room temperature is between approx. 21°C and 25°C

Common, etc.

Q9

There is a difference between the room temperature setting and actual room temperature.

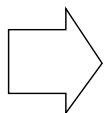

A9

There may be a difference between the room temperature setting and actual room temperature on account of the room structure, air flow, etc.
If there is a difference from the room temperature, adjust the set temperature to keep living space at a comfortable temperature.

Q10

What will happen if the time setting is changed while in a timer operation?

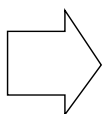

A10

A timer operation is performed until the time after changing the time setting.

Q11

In the "Automatic fan speed" mode, the indoor fan changes to MED and LO fan speed.

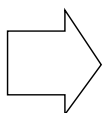

A11

It is not a trouble. The cold wind preventive function operates.

Set the temporary switch normal.

Nice temperature reservation

Q12

In case of "ON" timer, the operation does not start at a preprogrammed time but a little earlier.

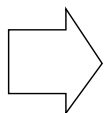

A12

The "Nice temperature reservation" functions. The operation starts earlier so the room temperature will be as set at a programmed time.
The operation starts at most 60 minutes before a preprogrammed time.

Q13

The time to start an operation is irregular while preprogramming at the same time.

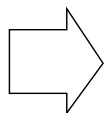

A13

The "Nice temperature reservation" operates. The starting time depends on the room load.

Q14

- 1) When the "Automatic" operation mode is selected, "Automatic" does not change by pressing the fan speed select button.
- 2) The room temperature setting is not displayed.
- 3) Pressing the room temperature control button develops transmit mark "📶" and sounds a receive sound but does not display the room temperature setting.

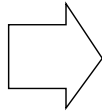

A14

- 1) When the operation mode is "Automatic", the fan speed is automatically fixed to "Automatic".
- 2) At an "Automatic" operation, the room temperature setting is not displayed. The room temperature is automatically set as follows.
At cooling
Set at 27°C.
At dehumidifying
Set to a temperature slightly lower than the room temperature.
- 3) At an "Automatic" operation, the room temperature setting is not displayed. However, every pressing "Λ" or "V" button changes 1°C within the range of:
27±3°C when cooling.

The room temperature sensing thermistor in the indoor unit detects the room temperature and, according to the particular temperature, automatically performs "Cooling" or "Dehumidifying" operation. The value indicated not at an "Automatic" but manual operation is not the actual room temperature but the room temperature setting.

Q15

When the room temperature setting is "16", pressing the room temperature control button "V" causes no transmission. At "32", pressing "Λ" causes no transmission either.

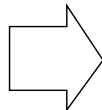

A15

The room temperature is settable within the range of 16 - 32 and not beyond.

Q16

The timer cannot be set.

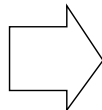

A16

Is the current time set?
The timer cannot be set unless the clock is adjusted correctly.

Q17

The current time disappears soon.

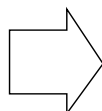

A17

The current time disappears soon and the timer setting indication takes a precedence.

When setting the current time, its indication blinks for approximately 3 minutes.

Q18

In spite of timer “Preprogram”, the time setting is extinguished.

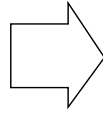

A18

Isn't the time over the pre-programmed time?
As soon as the pre-programmed time is reached, the time setting disappears.

Q19

After selecting a “Dehumidifying” operation mode, the fan speed mode remains “LO” fan speed”.

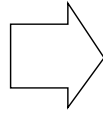

A19

At a “Dehumidifying” operation, the “LO” fan speed” is forcibly selected.

TROUBLE-SHOOTING

No cooling

Operates by setting the service switch to forced cooling?

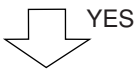

Return the service switch to "Normal".



Set the remote controller to an operation status and press the ON/OFF button.



Is the level LO (approx. 0.5V) between driver IC701 pin ⑮ power relay and 0V?



Is voltage normal between Blue wire and Red wire of Indoor DC Fan Motor *3



No operation at all.

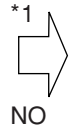

*1 Before using the service switch, disengage and engage the plug. Do not operate the remote controller.

Check the following parts and replace if faulty	
1) Current fuse	Remove and check the continuity across.
2) Varistor	Check whether the appearance is blackish or not. The resistance must be infinite. *2
3) Power switch	Check the continuity between contacts.
4) Thermal fuse for terminal board	(96°C) Continuity across → If there is no continuity, also check the fan motor and capacitor.
5) Thermal fuse for Terminal board	(102°C) Continuity across → If there is no continuity, check the electric parts and replace if abnormal.

*2 Before checking the varistor, detach a terminal.

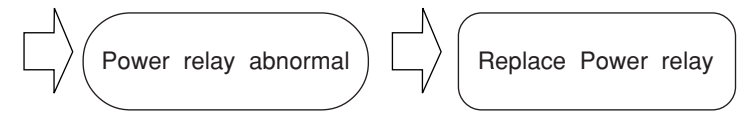

YES
Compressor does not turn at LO.

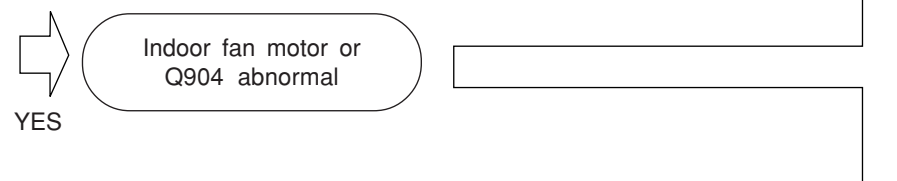

YES

Is voltage normal (approx. 280 ~ 300V) at out put side of the DB201?



YES

Check the circuit board of control board

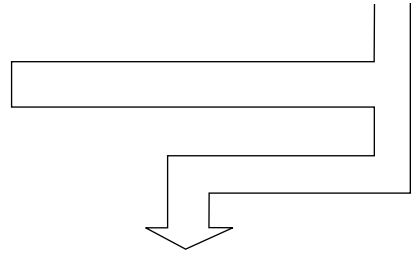

Check the circuit board inside parts. When checking, carry out a self diagnosis by indoor indicator lamp.

*4 Wait for 3 minutes before forced re-operation by the service switch.



Replace faulty part

*3

Fan Speed	CN6 BLUE-RED (V)
	RAS-18G4
	Cooling
HI	30.0
MED	26.0
LO	22.0

Timer-Lamp, break-down checking in blinking sign.

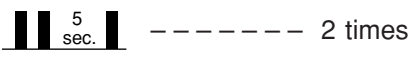
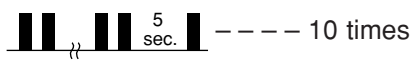
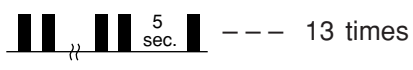
Check the break-down factor from the frequency of timer-lamp blinking.

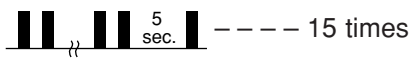
No.	Mode of Timer-Lamp blinking	Indication Factor	Estimated Break-Down Part
1	 2 times	<u>Force cooling operation</u> Unit is under forcible operation or under balancing after forcible operation.	Check force cooling switch at indoor electrical.
2	 10 times	<u>DC Fan motor - over flow of electricity</u> Indoor - DC Fan motor has over flow of electricity.	(1) Indoor - Fan is locked. (2) Indoor - Fan motor damage. (3) Indoor - control circuit board.
3	 13 times	<u>IC 401 Data read wrongly</u> In case that data read from IC401 is wrong.	IC401 data is not in order.
4	 14 times	<u>Heat exchanger thermistor error</u> Heat exchanger thermistor open or short-circuit detected.	(1) Thermistor (2) Indoor - control circuit board.
5	 15 times	<u>Room thermistor error</u> Room thermistor error open or short-circuit detected.	(1) Thermistor (2) Indoor - control circuit board.

( -- 0.5 second on, 0.5 second off.)

CAUTION

Remote control is disabled while the Timer lamp is flashing.
To check operation, turn off the power switch and turn it on again.

PARTS LIST AND DIAGRAM

INDOOR UNIT MODEL : RAS-18G4

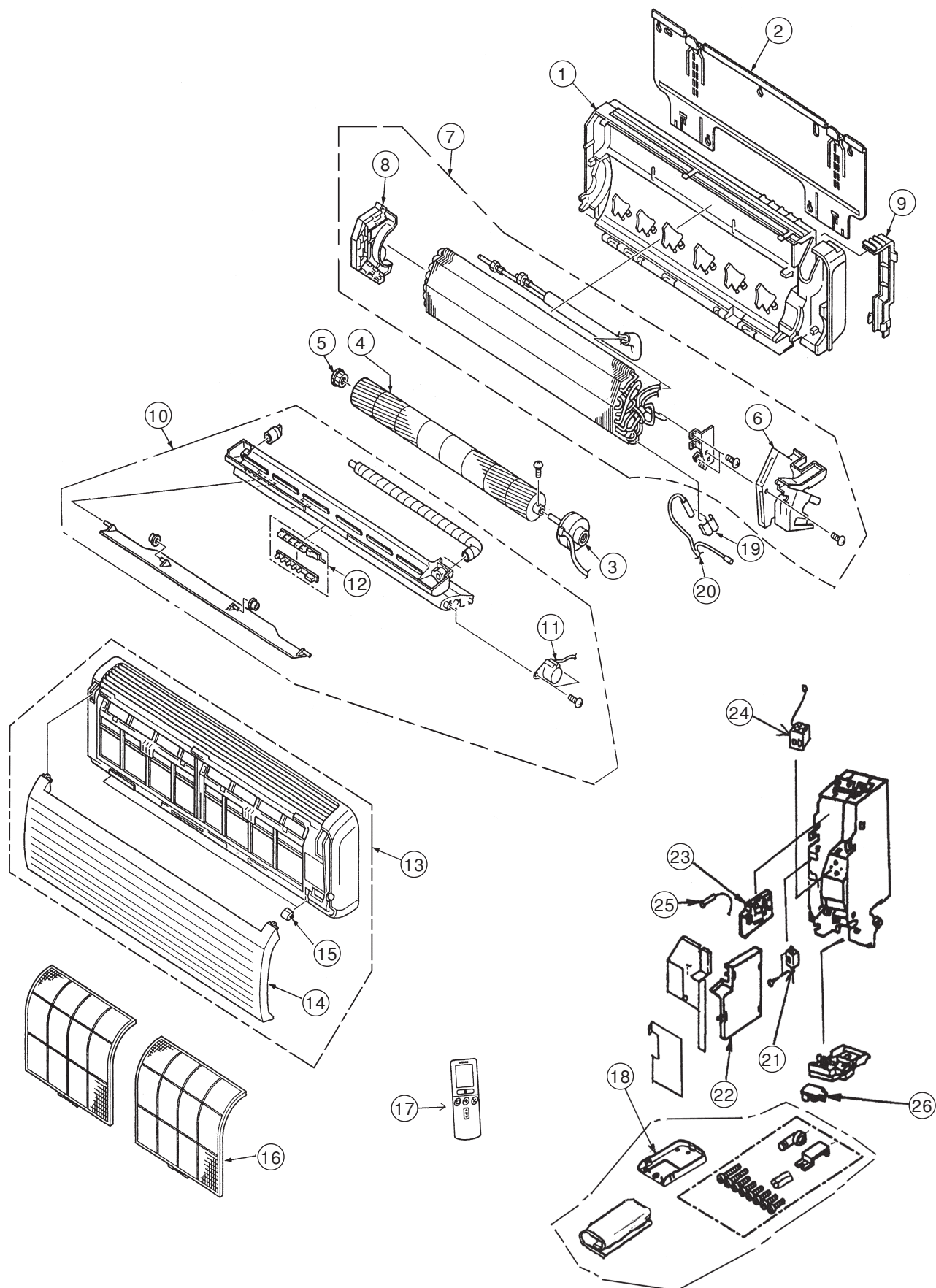

MODEL RAS-18G4

NO.	PART NO. RAS-18G4	Q'TY / UNIT	PARTS NAME
1	PMRAS-18GH4 002	1	CABINET
2	PMRAS-40CNH2 023	1	MOUNTING PLATE
3	PMRAS-51CHA1 002	1	FAN MOTOR
4	PMRAS-51CHA1 003	1	TANGENTIAL FAN
5	PMRAS-25CNH2 005	1	P-BEARING ASSY
6	PMRAS-51CHA1 004	1	FAN MOTOR BASE
7	PMRAS-18GH4 003	1	CYCLE ASSY
8	PMRAS-51CHA1 020	1	FAN COVER
9	PMRAS-18CP5 003	1	PIPE SUPPORT
10	PMRAS-63CA2 003	1	DRAIN PAN ASSY
11	PMRAS-51CHA1 008	1	AUTO SWEEP MOTOR
12	PMRAS-63CA2 005	1	P.W.B (LED)
13	PMRAS-18GH4 004	1	FRONT COVER ASSY
14	PMRAK-60NHA 008	1	FRONT PANEL
15	PMRAS-10C7M 008	3	CAP
16	PMRAS-51CHA1 010	2	FILTER
17	PMRAS-51CA1 002	1	REMOTE CONTROL ASSY
18	PMRAS-10C3M 003	1	REMOTE CONTROL SUPPORT
19	PMRAS-51CHA1 015	1	THERMISTOR SUPPORT
20	PMRAS-51CHA1 016	1	THERMISTOR
21	PMRAS-18CP2R 002	1	POWER SWITCH
22	PMRAS-18G4 001	1	P.W.B (MAIN)
23	PMRAS-51CHA1 013	1	P.W.B (POWER SW SUPPLY)
24	PMRAS-51CHA1 017	1	TERMINAL BOARD (FUSE)
25	PMRAS-51CHA1 018	1	THERM-FUSE FOR P.C.B
26	PMRAS-51CHA1 019	1	P.W.B (RECEIVER)

PARTS LIST AND DIAGRAM

OUTDOOR UNIT MODEL : RAC-18G4

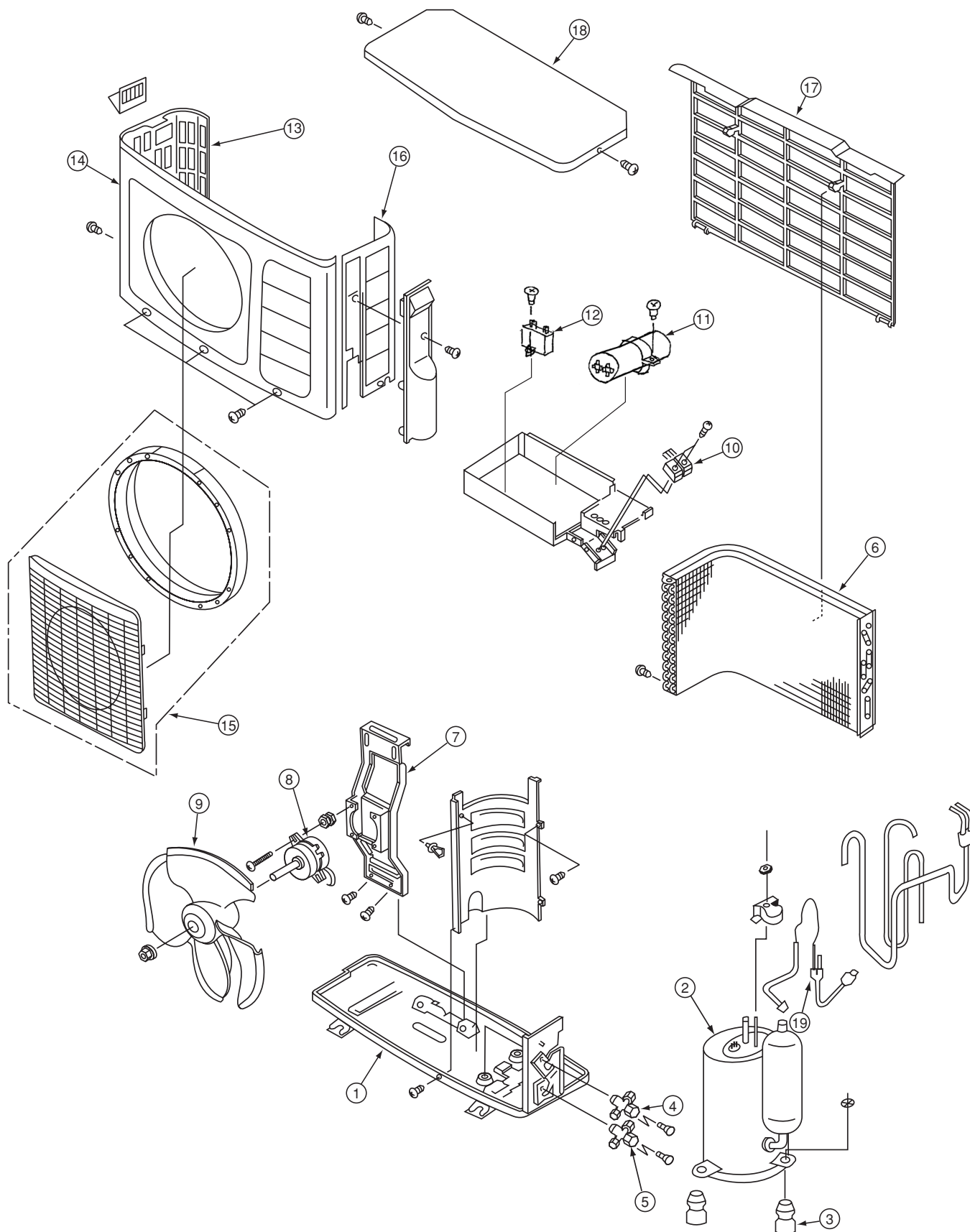

MODEL RAC-18G4

NO.	PART NO. RAC-18G4	Q'TY / UNIT	PARTS NAME
1	PMRAC-18GH4 907	1	BASE
2	PMRAC-18GH4 901	1	COMPRESSOR
3	PMRAC-18GH4 902	3	COMPRESSOR RUBBER
4	PMRAC-50NH4 903	1	VALVE (2S)
5	PMRAC-18GH4 905	1	VALVE (4S)
6	PMRAC-51CHA1 902	1	CONDENSER
7	PMRAC-40CNH2 918	1	FAN MOTOR SUPPORT
8	PMRAC-18CH1 901	1	FAN MOTOR
9	PMRAC-40CNH2 917	1	PROPELLER FAN
10	PMRAC-63CA1 902	1	TERMINAL BOARD (2P)
11	PMRAC-63CHA2 907	1	COMPRESSOR CAPACITOR
12	PMRAC-63CHA2 908	1	CAPACITOR 2.5 μ F
13	PMRAC-40CNH2 926	1	SIDE PLATE (L)
14	PMRAC-18CH1 903	1	CABINET
15	PMRAC-51CHA1 907	1	GRILL ASSY
16	PMRAC-40CNH2 923	1	SIDE PLATE (R)
17	PMRAC-24CP5 904	1	NET
18	PMRAC-40CNH2 922	1	TOP COVER
19	PMRAC-18G4 901	1	STRAINER (COND)

HITACHI

RAS-18G4 / RAC-18G4

PM NO. 0192E

Printed in Malaysia